



INSTALLATION INSTRUCTIONS

COLD AIR INTAKE KIT
2011 JEEP GRAND CHEROKEE 5.7L HEMI V8
2011 DODGE DURANGO 5.7L HEMI V8

PART NUMBER 77070041

Bill of Materials for 77070041

A	1	2-1463	Intake Tube
B	1	32-3083	Heat Shield Bracket
C	1	20-8518	Heat Shield
D	1	MP-M-1003	Air Filter Assembly 3.5" x 7" Dry Element
E	1	8-120	Elbow Fitting, 5/8"
F	1	5-7013	Hose, 5/8" ID X 13"
G	1	8-185	Hose Adaptor, 3/4" to 5/8"
H	1	08058	Grommet 3/4" ID
I	1	1-127	Zip Tie, 8" Push-Mount
J	1	8-4024	Rubber Edge Trim 24"
K	1	8-3014	Thin Rubber Edge Trim 14"
L	2	08373	M6 X 16mm Bolt
M	1	784634	Grommet 1/2" ID
N	1	08654	Hose, 3.50 X 2" BLK
O	2	9456	Hose Clamp, 3.15" – 4.00"
P	1	08318	M8 X 16mm Bolt
	1	K6857276	Instructions
	1	11-77070041	CARB EO Decal

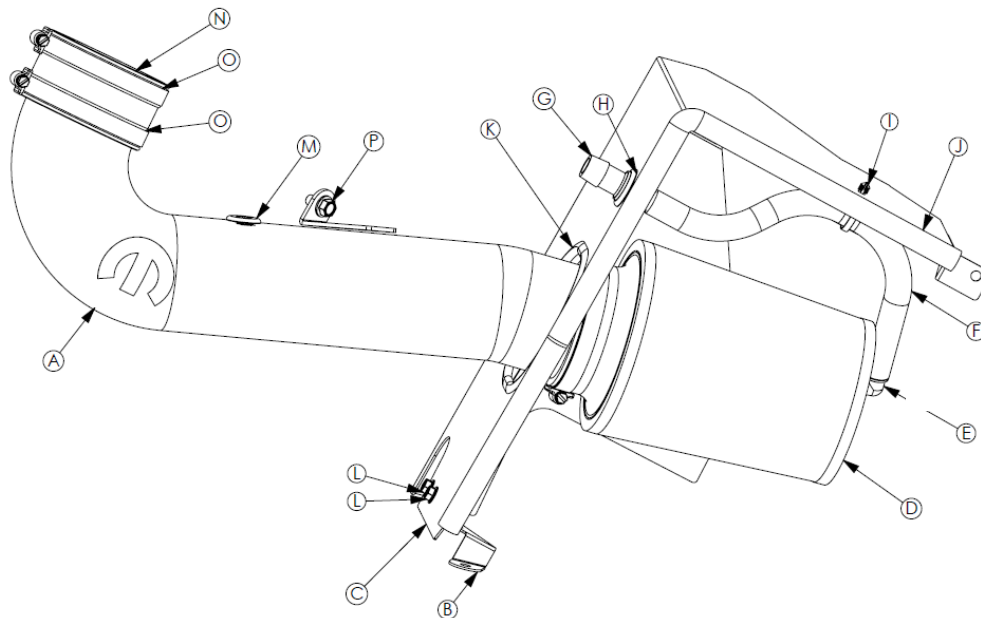



INSTALLATION INSTRUCTIONS

COLD AIR INTAKE KIT

2011 JEEP GRAND CHEROKEE 5.7L HEMI V8

2011 DODGE DURANGO 5.7L HEMI V8

PART NUMBER 77070041



IMPORTANT:

This kit includes a Dry Filter. **DO NOT APPLY ANY OIL TO THIS FILTER!** See step 5 for cleaning instructions.

Read and understand these instructions **BEFORE** attempting to install this product.

1) Getting Started

- a) Make sure vehicle is parked on a level surface.
- b) Set parking brake.
- c) Disconnect negative battery terminal.
- d) If engine has run within the past two hours let it cool down.

2) Removing the stock air intake system



a) Your factory air intake system should look like this.



b) Remove the engine cover by pulling straight up.



INSTALLATION INSTRUCTIONS

COLD AIR INTAKE KIT
2011 JEEP GRAND CHEROKEE 5.7L HEMI V8
2011 DODGE DURANGO 5.7L HEMI V8
PART NUMBER 77070041

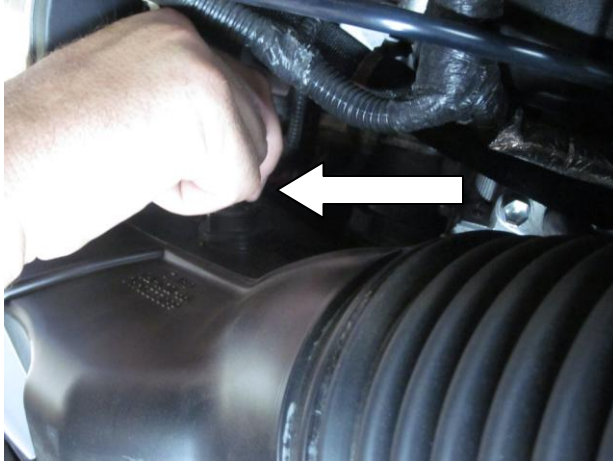

c) Disconnect the inlet air temperature (IAT) sensor wire harness from the sensor. Leave the sensor in place.



d) Loosen and remove the M6 air inlet chamber mounting bolt.

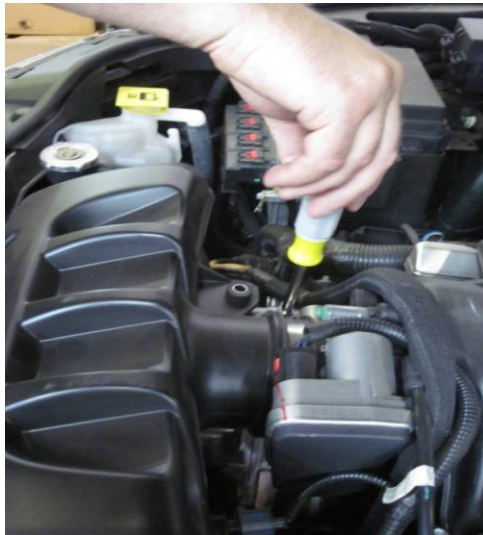

e) Loosen the hose clamp at the throttle body.

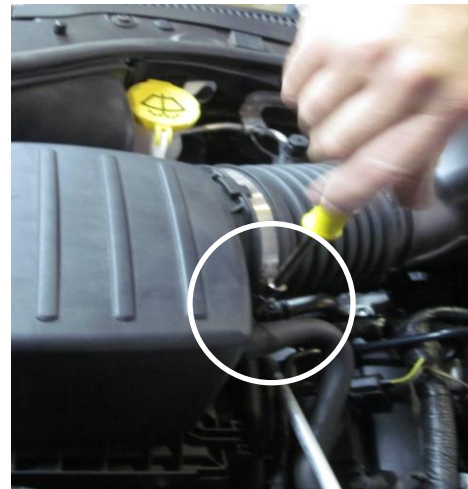

f) Loosen the hose clamp at the air box.



INSTALLATION INSTRUCTIONS

COLD AIR INTAKE KIT
2011 JEEP GRAND CHEROKEE 5.7L HEMI V8
2011 DODGE DURANGO 5.7L HEMI V8
PART NUMBER 77070041



g) Remove the air inlet hose from the engine bay.

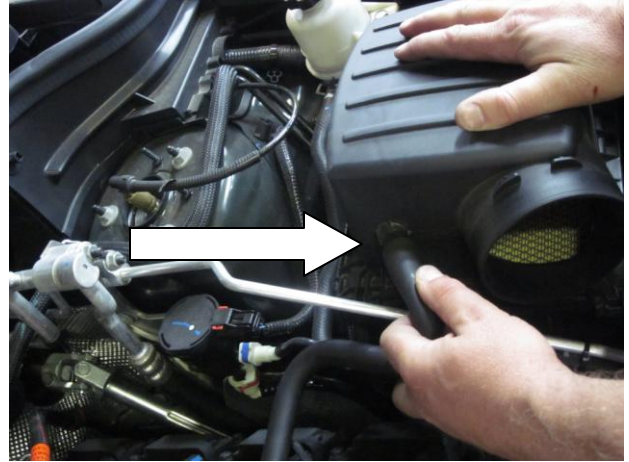

h) Detach the valve cover breather hose from the air box.



i) Detach the air inlet duct from the rubber edge trim.



j) Lift and remove the air box from the engine bay.



INSTALLATION INSTRUCTIONS

COLD AIR INTAKE KIT

2011 JEEP GRAND CHEROKEE 5.7L HEMI V8

2011 DODGE DURANGO 5.7L HEMI V8

PART NUMBER 77070041



k) Loosen and remove the M8 bolt securing the power steering fluid reservoir. The bolt will be reused later.



l) Remove the plastic clip securing the windshield washer fluid reservoir to the core support.



INSTALLATION INSTRUCTIONS

COLD AIR INTAKE KIT

2011 JEEP GRAND CHEROKEE 5.7L HEMI V8

2011 DODGE DURANGO 5.7L HEMI V8

PART NUMBER 77070041

3) Installing the MOPAR Cold Air Intake

*When installing the MOPAR Cold Air Intake System, DO NOT completely tighten the hose clamps or mounting tab hardware until instructed to do so later in these instructions. Check to see that the inside of the inlet tubes and air filter are clean and free from any foreign objects and/or obstructions.

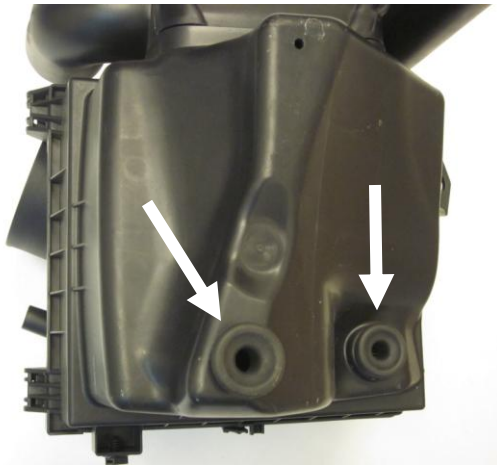

a) Remove the rubber grommets from the bottom of the air box.

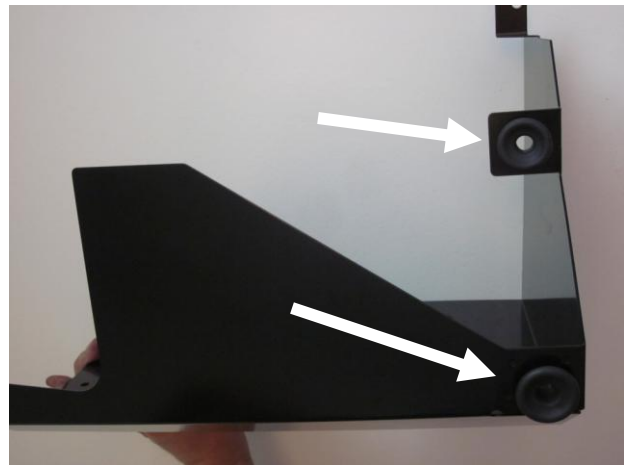

b) Insert the grommets into the hole on the bottom of the heat shield as shown.



INSTALLATION INSTRUCTIONS

COLD AIR INTAKE KIT

2011 JEEP GRAND CHEROKEE 5.7L HEMI V8

2011 DODGE DURANGO 5.7L HEMI V8

PART NUMBER 77070041

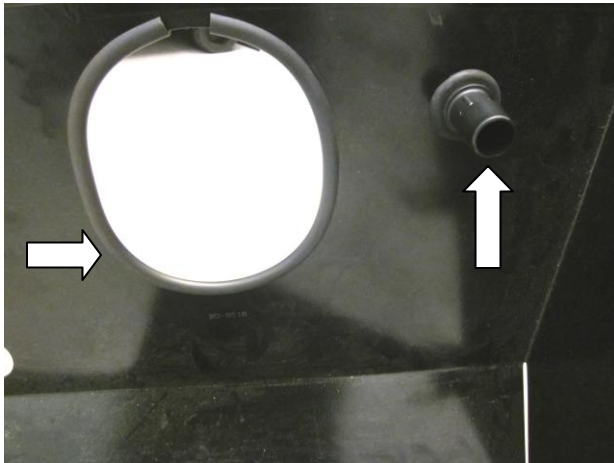

c) Install the supplied grommet and straight hose adaptor into the heat shield and install the supplied thin edge trim around the opening as shown. **Note: The 5/8" end of the fitting goes on the outside of the heat shield.**



d) Install the supplied heat shield bracket to the core support with factory 6mm bolt. Do not completely tighten the bolt at this time.

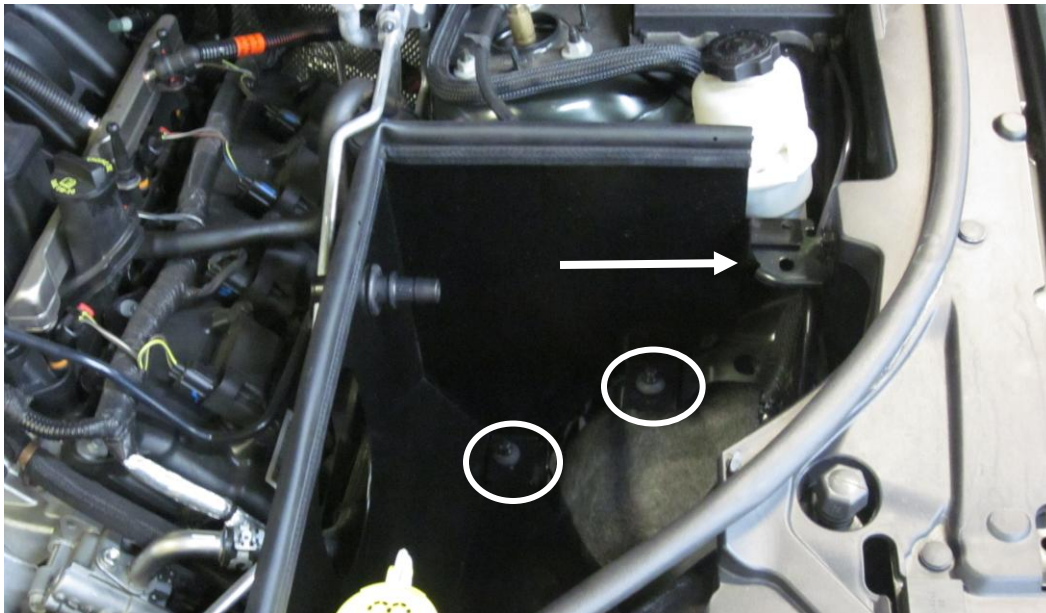

e) Line up the grommets to the two studs and place the heat shield in place; Install the thick rubber edge trim on top of the heat shield.



INSTALLATION INSTRUCTIONS

COLD AIR INTAKE KIT

2011 JEEP GRAND CHEROKEE 5.7L HEMI V8

2011 DODGE DURANGO 5.7L HEMI V8

PART NUMBER 77070041



f) Place the power steering fluid reservoir tab over the MOPAR heat shield bracket and install the factory M8 bolt. Do not tighten completely at this time.



g) Attach the heat shield to the bracket installed in step d) with supplied M6 bolts.

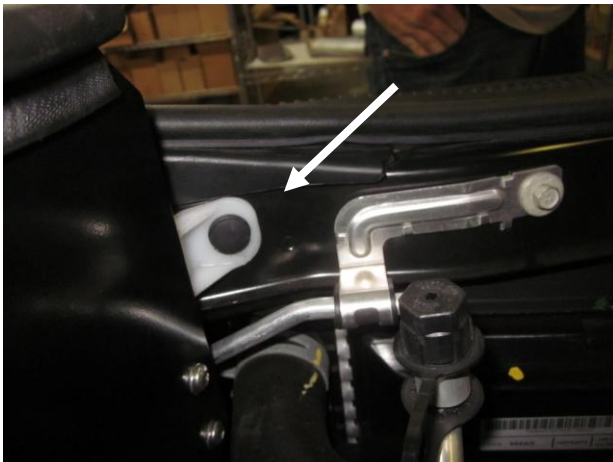

h) Place the windshield washer reservoir back in its place and reinstall the plastic clip removed from page 5 step l).



i) From the factory air inlet tube, twist and remove the inlet air temperature (IAT) sensor.



INSTALLATION INSTRUCTIONS

COLD AIR INTAKE KIT
2011 JEEP GRAND CHEROKEE 5.7L HEMI V8
2011 DODGE DURANGO 5.7L HEMI V8

PART NUMBER 77070041



j) Once the IAT sensor is removed from the factory air inlet tube, use a suitable tool or pick to remove the small O-ring from the IAT sensor.
Note: Do not discard the O-ring.

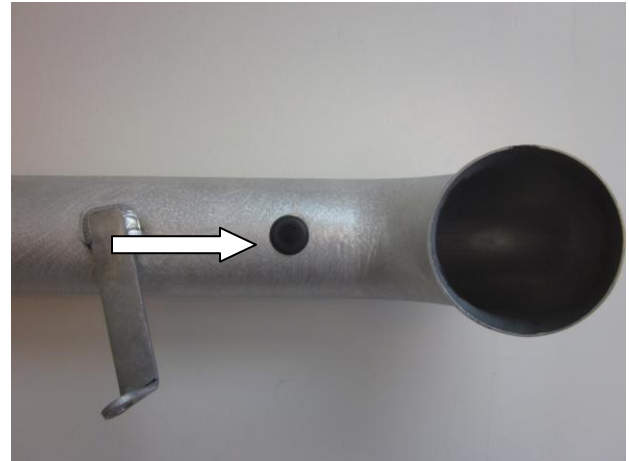

k) Install the supplied grommet into the hole on the MOPAR air intake tube.

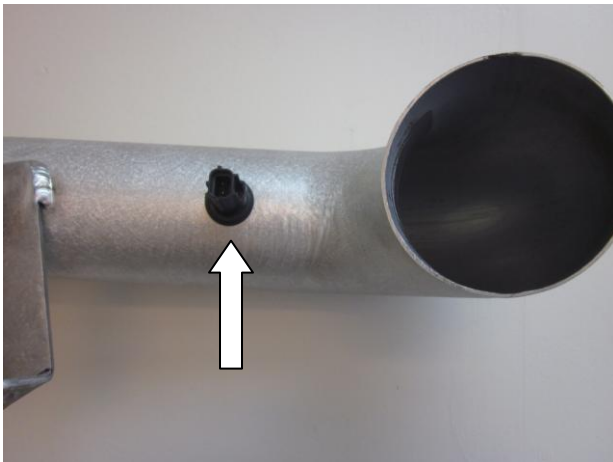

l) With the O-ring removed, insert the IAT sensor into the MOPAR air intake tube as shown.

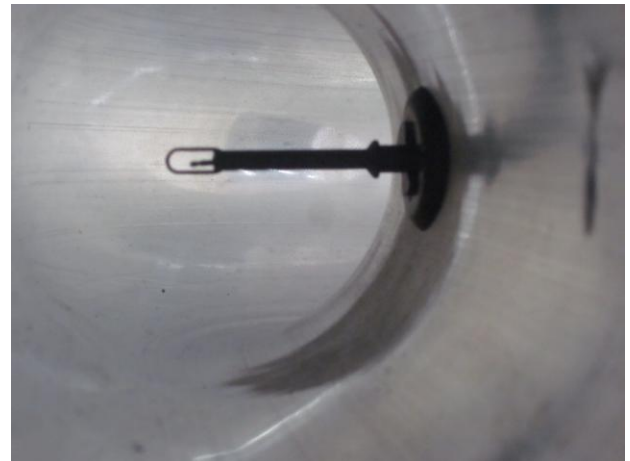

m) This is what the IAT sensor probe looks like inside the tube when sensor is properly inserted.
Note: The orientation of the sensor probe in the tube does not affect performance.



INSTALLATION INSTRUCTIONS

COLD AIR INTAKE KIT
2011 JEEP GRAND CHEROKEE 5.7L HEMI V8
2011 DODGE DURANGO 5.7L HEMI V8

PART NUMBER 77070041

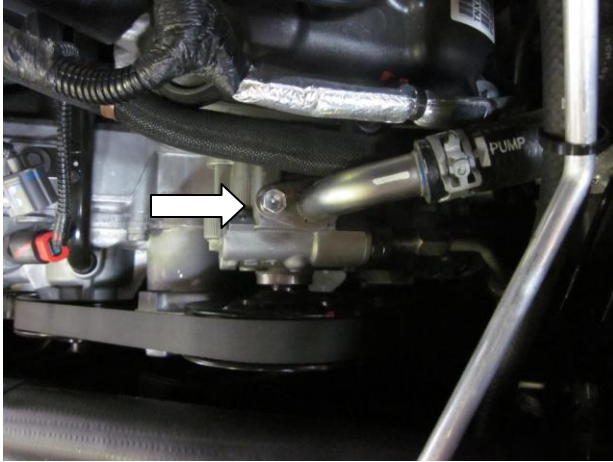

n) Loosen and remove the M8 bolt from the power steering pump housing. This bolt will not be reused.

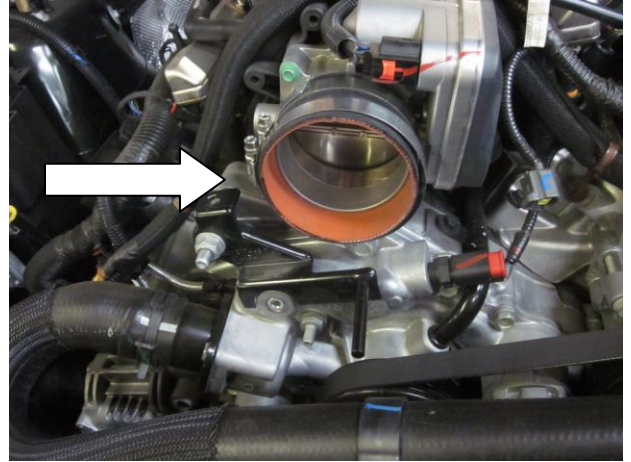

o) Install the supplied 3 1/2" ID hose on the throttle body along with the supplied #56 hose clamps.



p) Install the MOPAR air intake tube to the throttle body and through the heat shield opening.



q) Attach the bracket on the MOPAR air intake tube to the power steering pump with the supplied M8 bolt.



INSTALLATION INSTRUCTIONS

COLD AIR INTAKE KIT 2011 JEEP GRAND CHEROKEE 5.7L HEMI V8 2011 DODGE DURANGO 5.7L HEMI V8

PART NUMBER 77070041

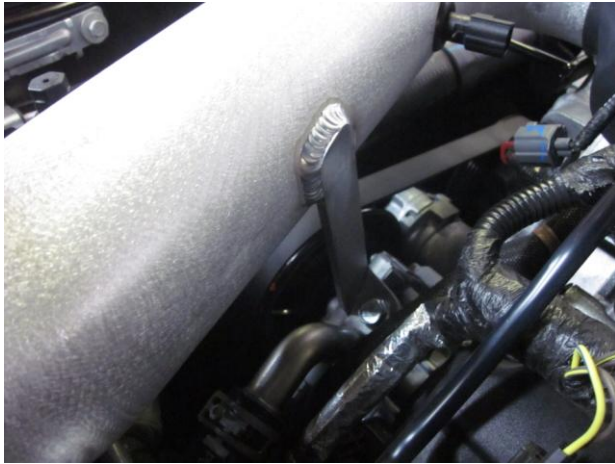

r) This is how the bracket should look when properly installed.



s) With the MOPAR air intake tube properly aligned, tighten all hose clamps, nuts and bolts installed in the previous steps.



t) Install the elbow vent fitting to the MOPAR air filter top and attach the supplied 5/8" id hose to the fitting.

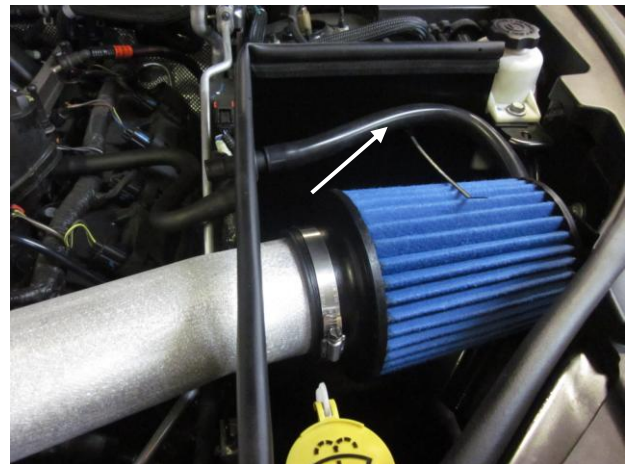

u) Attach the filter to the MOPAR air intake tube and attach the vent hose to the vent fitting on the heat shield. Clip the supplied zip tie to the heat shield.



INSTALLATION INSTRUCTIONS

COLD AIR INTAKE KIT
2011 JEEP GRAND CHEROKEE 5.7L HEMI V8
2011 DODGE DURANGO 5.7L HEMI V8
PART NUMBER 77070041



v) Wrap the zip tie around the vent hose to hold it in place.

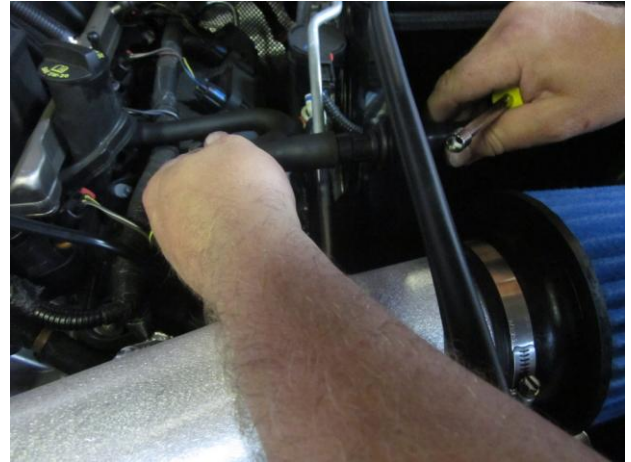

w) Attach the valve cover breather hose to the other end of the straight vent fitting.

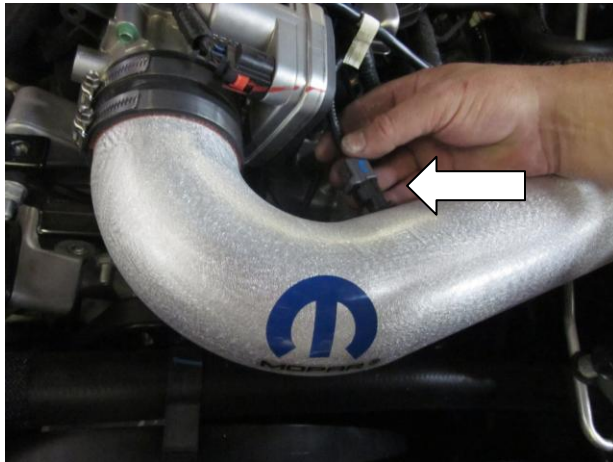

x) Connect the IAT wire harness to the sensor.



y) Reinstall the engine cover.



INSTALLATION INSTRUCTIONS

COLD AIR INTAKE KIT

2011 JEEP GRAND CHEROKEE 5.7L HEMI V8

2011 DODGE DURANGO 5.7L HEMI V8

PART NUMBER 77070041



This is how the MOPAR air intake system should look when properly installed.

3) Re-Assemble the vehicle.

- a) Inspect the engine bay for any loose tools and check that all fasteners that were moved or removed are properly tight.
- b) Re-check clearance of all hoses and tighten all hose clamps.
- c) Reconnect negative battery terminal.
- d) Start engine. Let car idle for 3 minutes. Perform a final inspection before driving the vehicle.



INSTALLATION INSTRUCTIONS

COLD AIR INTAKE KIT

2011 JEEP GRAND CHEROKEE 5.7L HEMI V8

2011 DODGE DURANGO 5.7L HEMI V8

PART NUMBER 77070041

4) Dry Filter cleaning procedure

(It is recommended that you service your MOPAR air filter every 20,000 miles for optimum performance.)

- Remove filter from intake pipe and set the filter clamp aside.
- Measure the length of the filter media.
- Fill a pail with warm clean water to the depth determined in Step b. Add a mild household detergent to the water.
- Without allowing the solution to flow into the filter neck, submerge the filter into the water and let it soak for 10 minutes. After soaking, rotate the filter back and forth to agitate the water and knock off dirt.
- Empty the bucket of dirty water. Repeat steps C and D.
- Refill the pail with clean warm water and rinse by rotating the filter as in step D. The water should be clear with no signs of dirt in the pail.
- Allow the filter to air dry. **DO NOT APPLY ANY OIL TO THIS FILTER.** Re-install the filter on the intake system once it is dry.

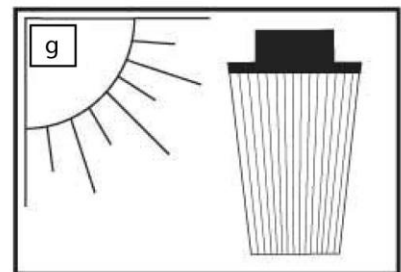
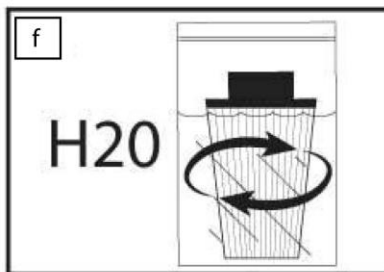
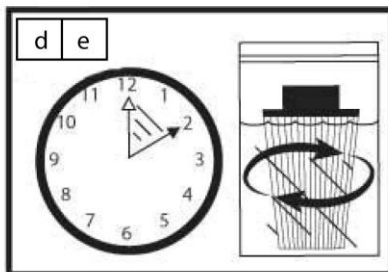
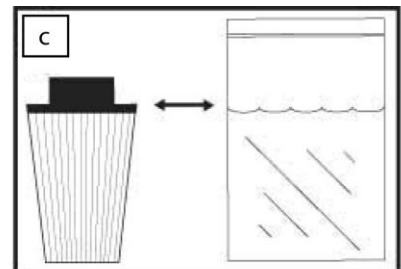
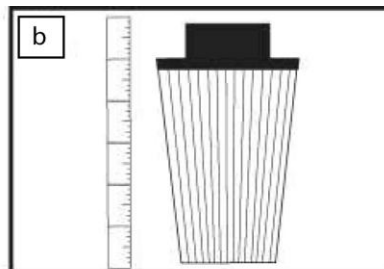
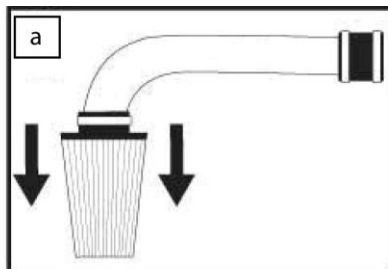

For technical assistance regarding MOPAR Cold Air Intake Systems, please call toll-free 1-888-528-HEMI (528-4364).