

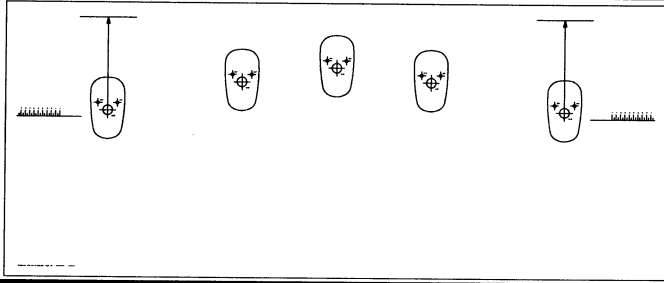

MOPAR.

DODGE RAM Clearance Lights



A

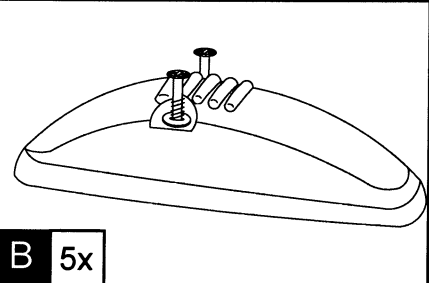

B 5x

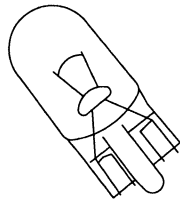

C 5x

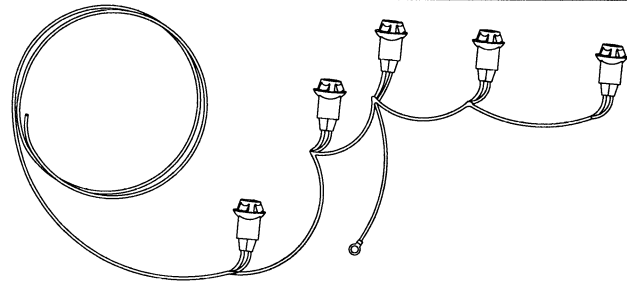

D

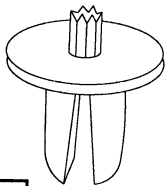

E 10x

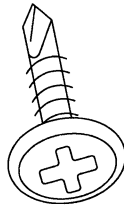

F

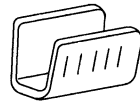

G



H 2x

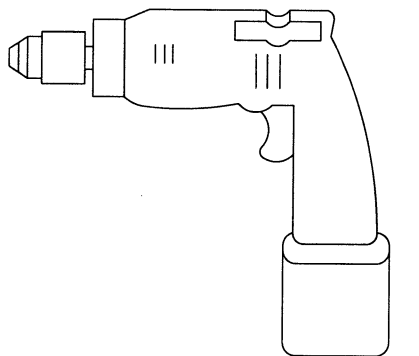

Ø 22mm(7/8")



Ø6.35mm(1/4")

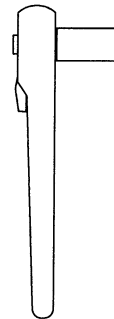

Remove headliner. Refer to vehicle shop manual.
Retire el toldo. Refiérase al manual de tienda del automóvil.
Enlevez le vaigrage. Référez au manuel.

1

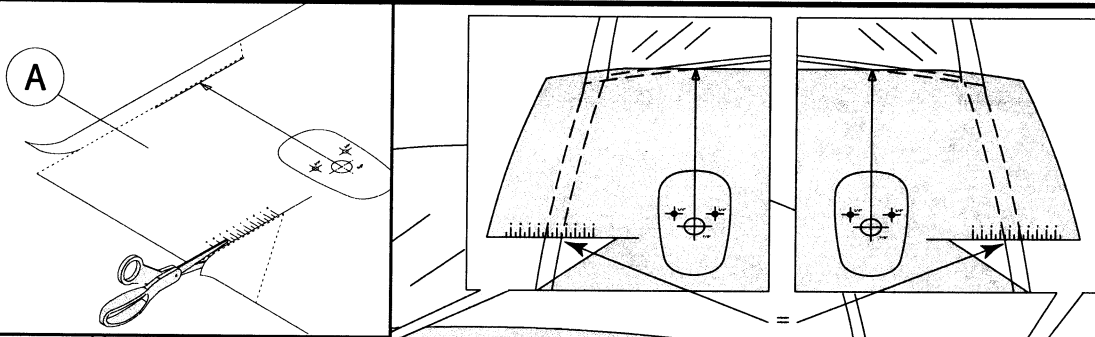

2

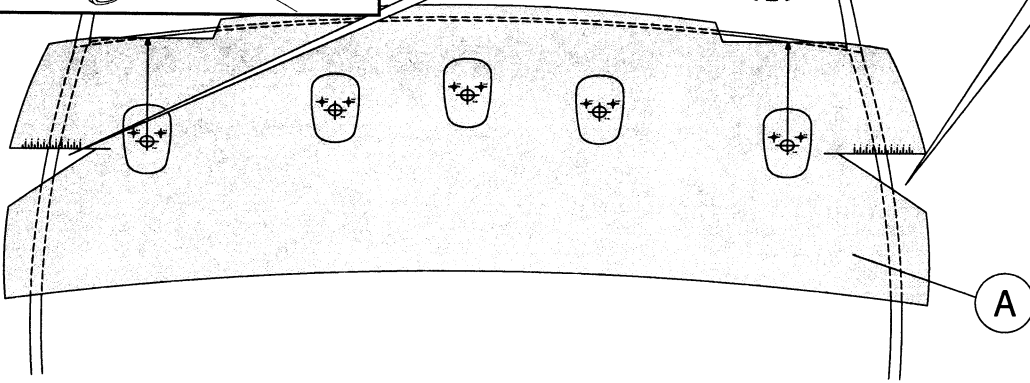

3

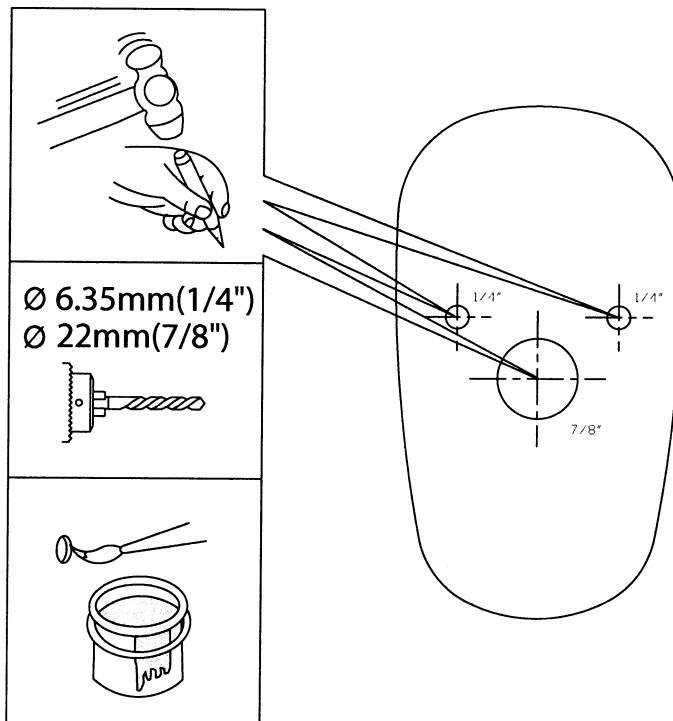

4

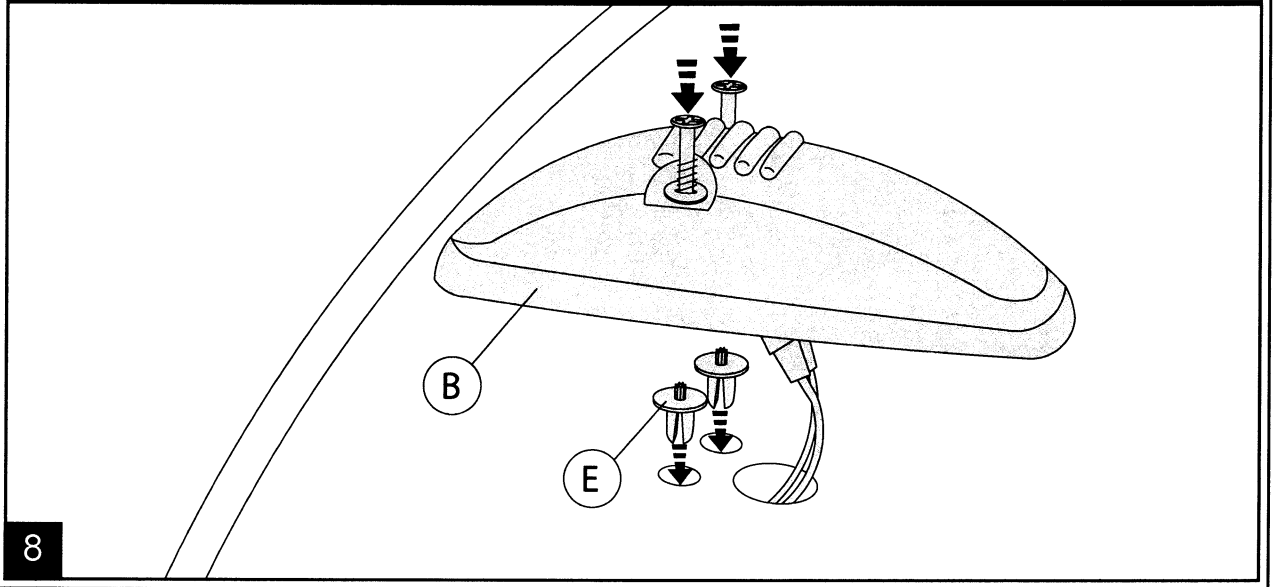
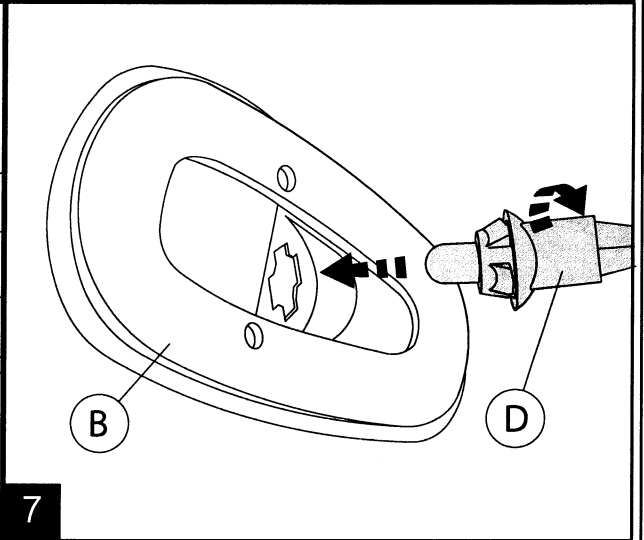
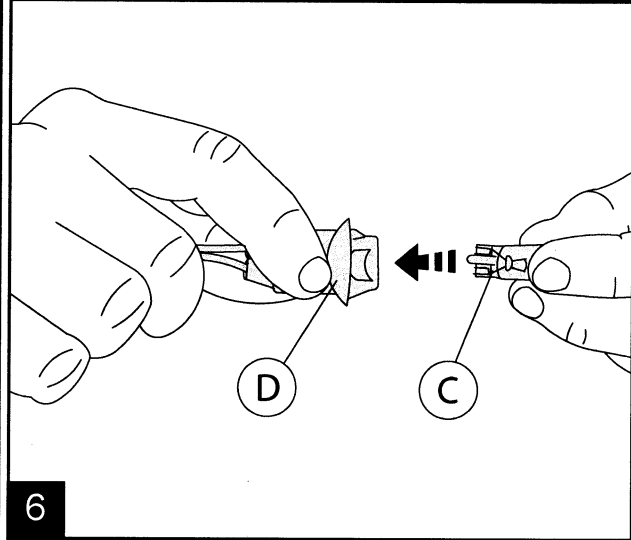
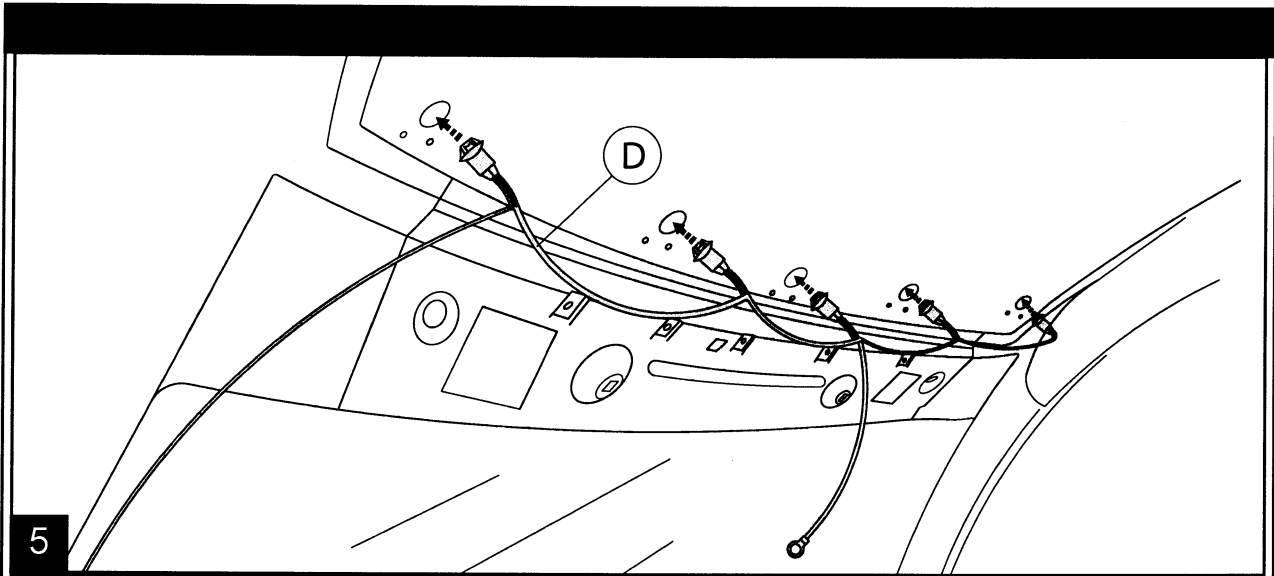

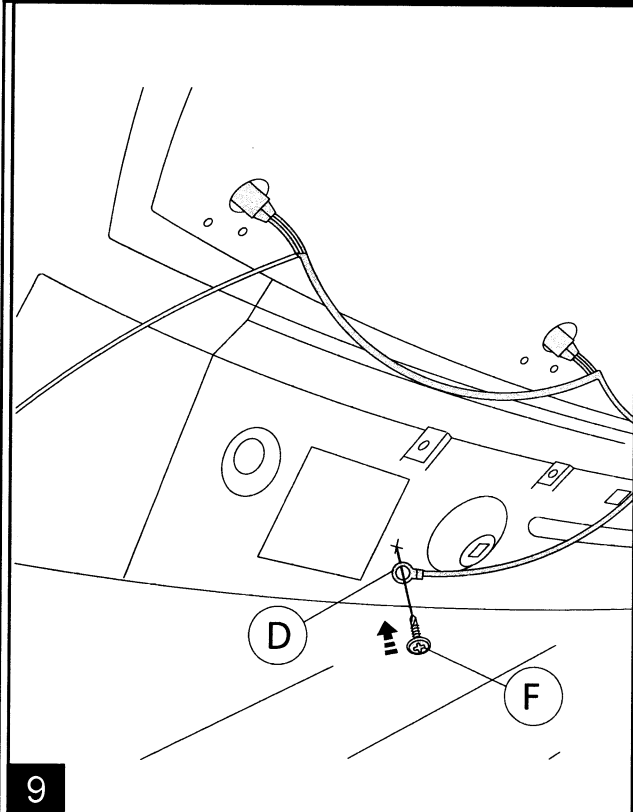

9

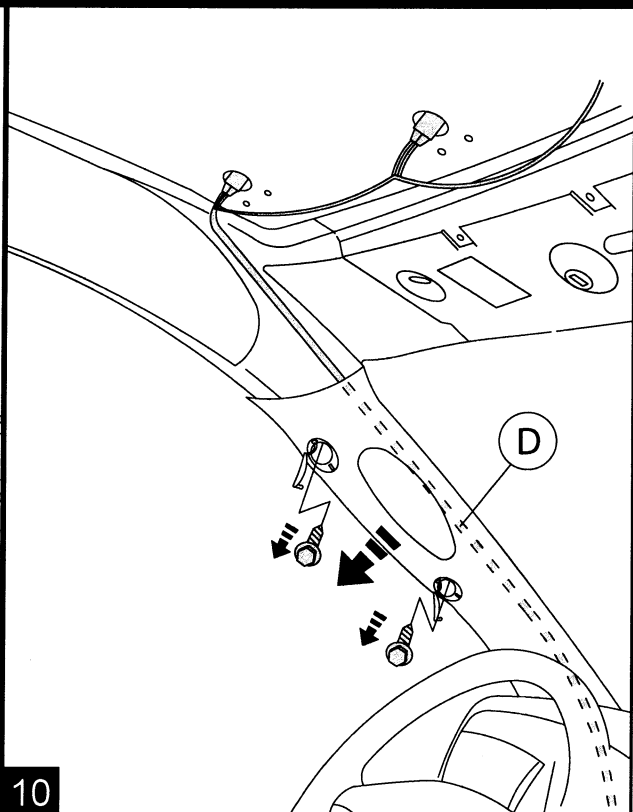

10

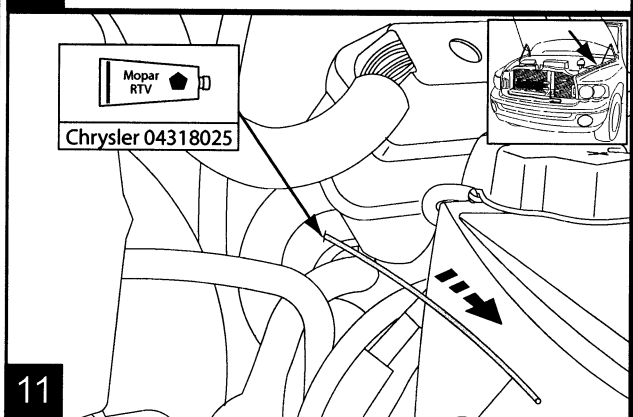

11

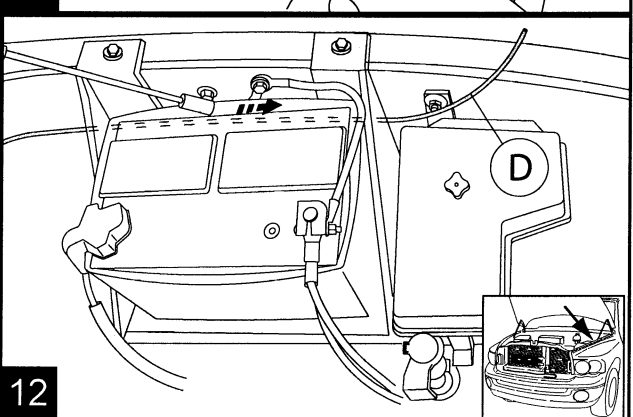

12

'05 and prior
'05 et avant

13

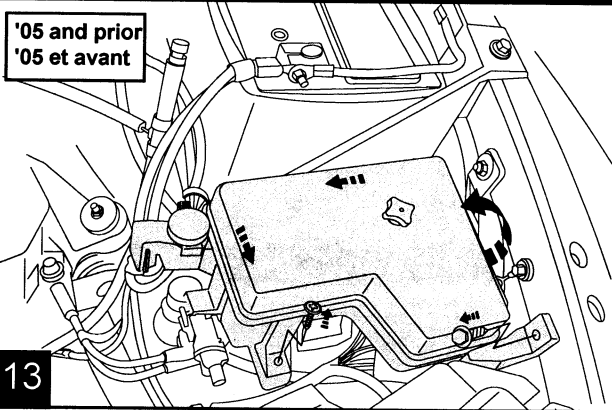

'05 and prior
'05 et avant

14

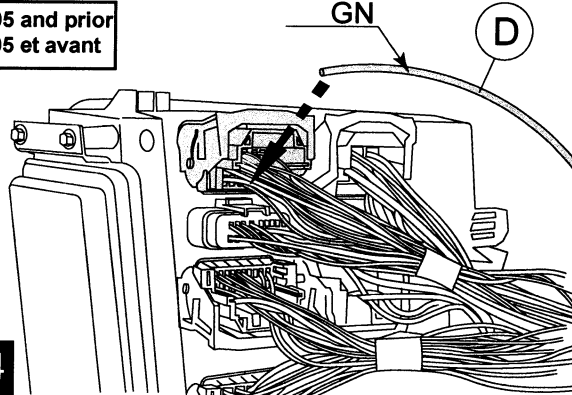

'06 and beyond
'06 et après

15

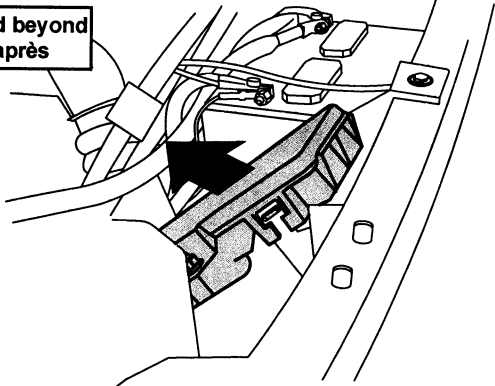

'06 and beyond
'06 et après

16

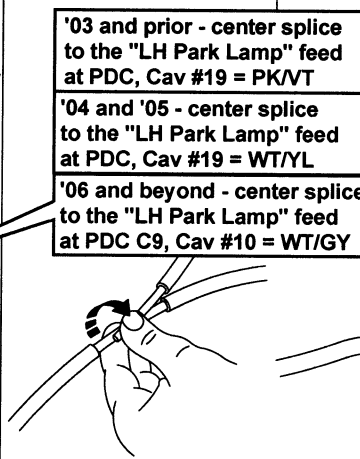
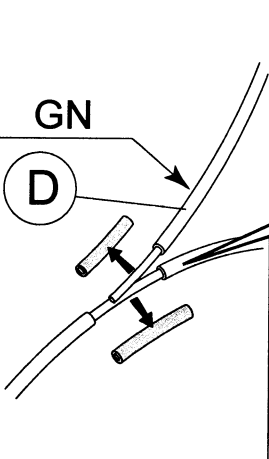
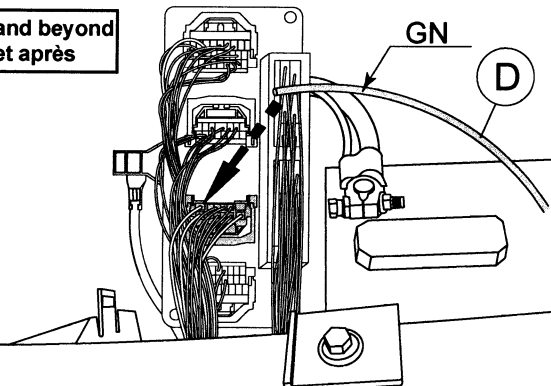

'03 and prior - center splice to the "LH Park Lamp" feed at PDC, Cav #19 = PK/VT	'03 et avant - brancher aux le fil de "garer la lampe gauche" a PDC, Cav #19 = PK/VT
'04 and '05 - center splice to the "LH Park Lamp" feed at PDC, Cav #19 = WT/YL	'04 et '05 - brancher aux le fil de "garer la lampe gauche" a PDC, Cav #19 = WT/YL
'06 and beyond - center splice to the "LH Park Lamp" feed at PDC C9, Cav #10 = WT/GY	'06 et après - brancher aux le fil de "garer la lampe gauche" a PDC C9, Cav #10 = WT/GY

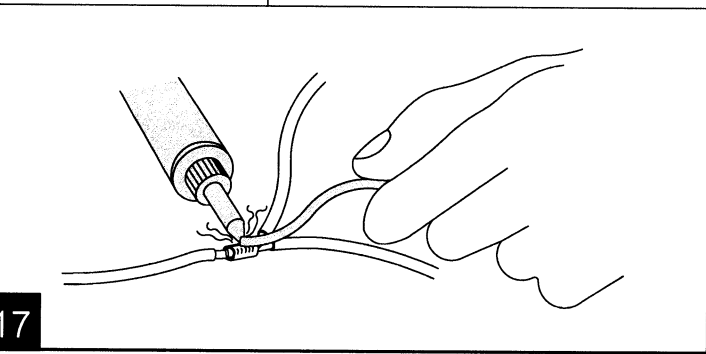
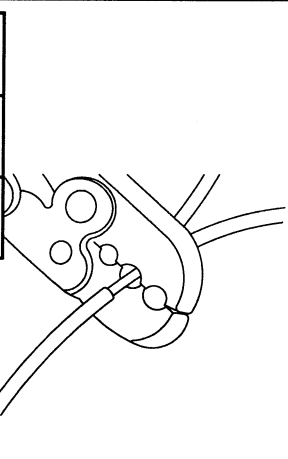

17

