

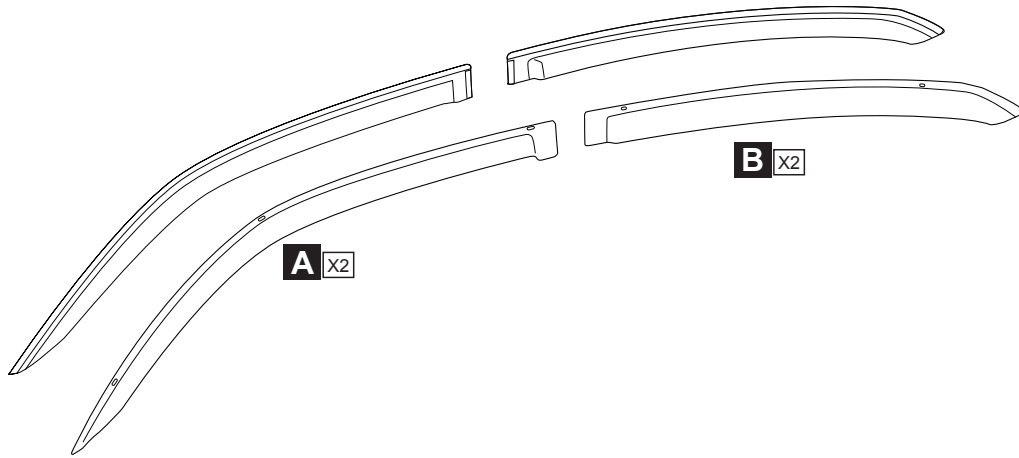

CHRYSLER 300

Side Window Deflectors

GENUINE ACCESSORIES



C X2



D X8



E X8

GB

INSTALLATION INSTRUCTION

DOOR VISORS

Parts must not be fitted until registration of the vehicle has been obtained.

Subject to alteration without notice
Reservadas modificaciones técnicas
Sous réserve de modifications techniques

Expert Fitment Required
Montaje sólo por el concesionario
Montage par spécialiste nécessaire



GENUINE ACCESSORIES

<p>105° F — 40° C 60° F — 20° C ✓</p>	<p>2</p>
<p>3</p>	<p>4</p>
<p>5</p>	<p>6</p>
<p>7</p>	<p>8</p>



GENUINE ACCESSORIES

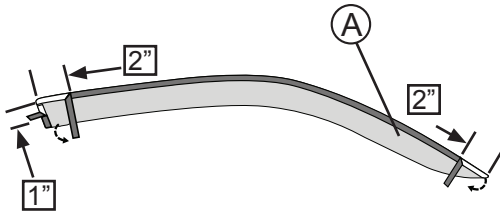

9

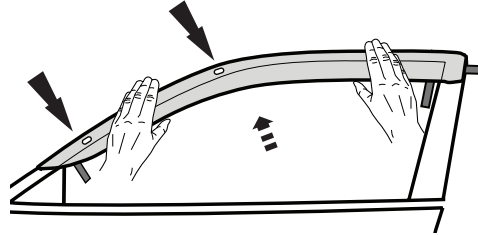

10

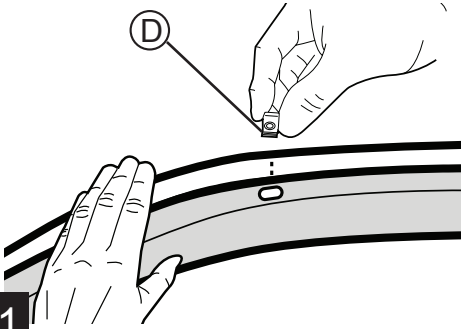

11

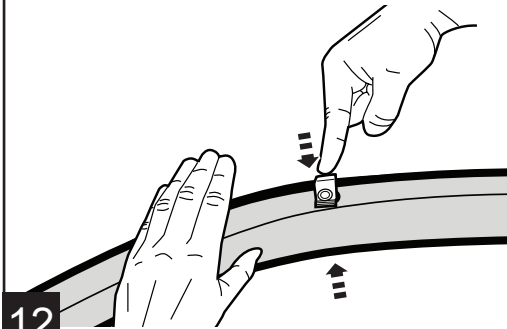

12

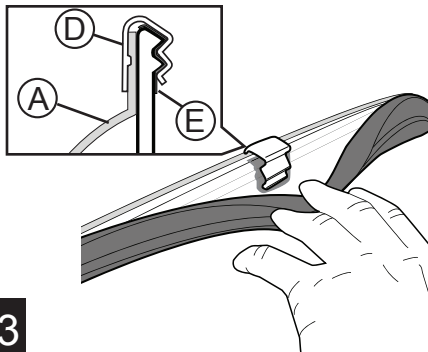

13

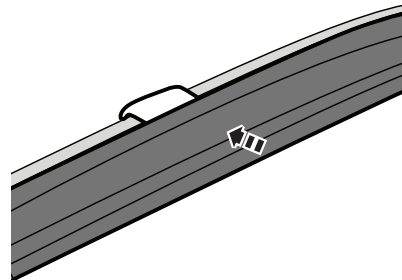

14

Refer to Step 19 for proper placement.

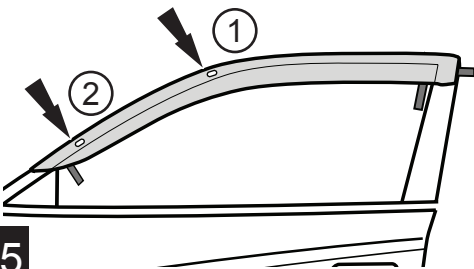

15

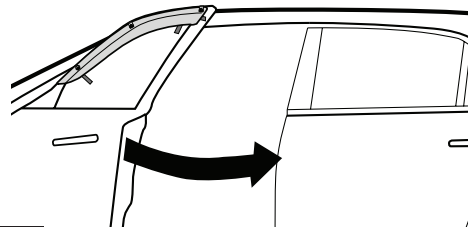

16



GENUINE ACCESSORIES

Lift visor slightly away from vehicle to assist with tape removal.



17

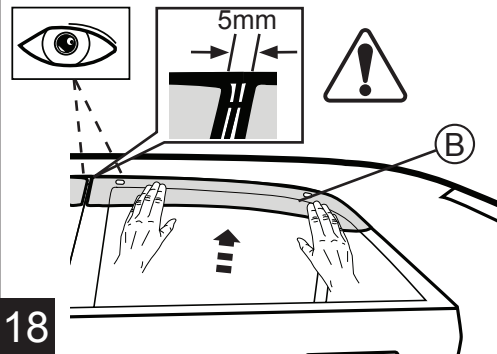

18

Apply firm even pressure for 30 seconds.

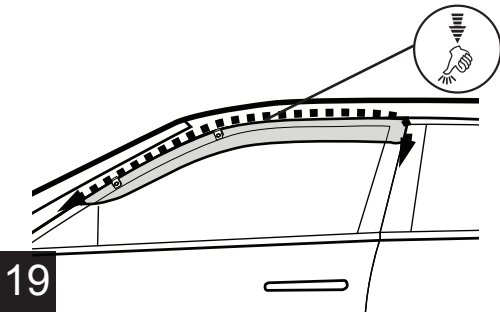

19

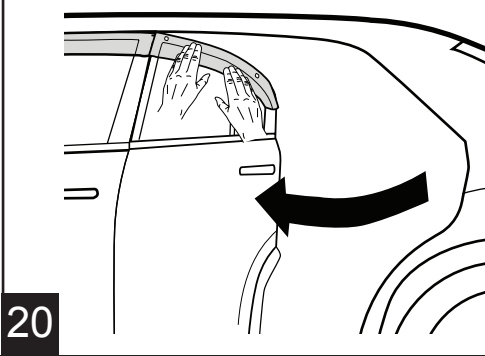

20

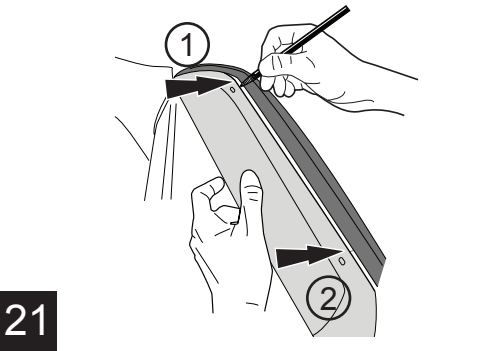

21

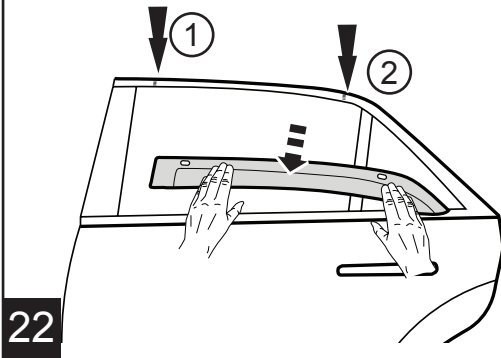

22

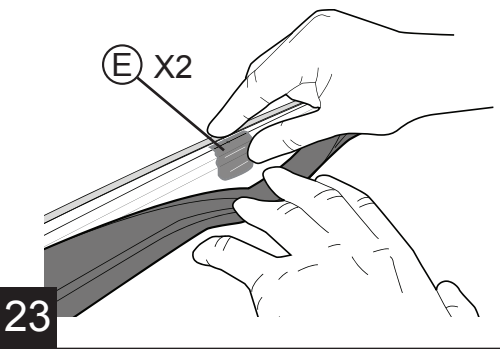

23

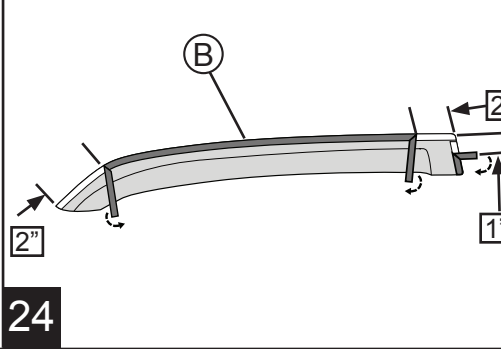

24



GENUINE ACCESSORIES

Refer to Step 19 for proper placement.

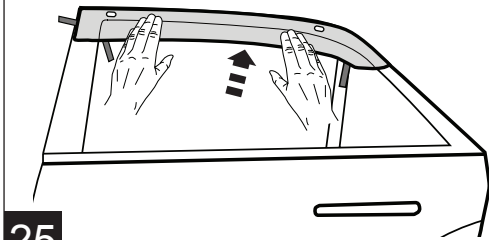

25

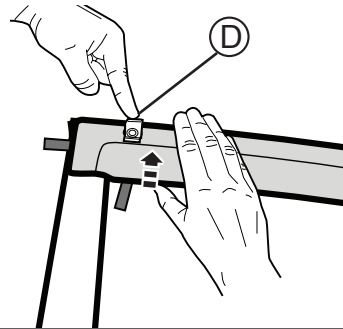

26

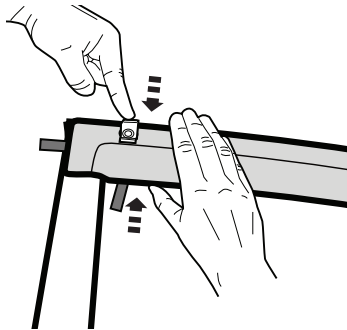

27

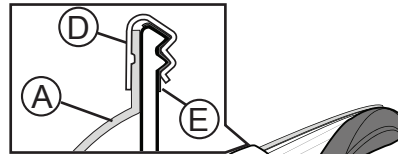

28

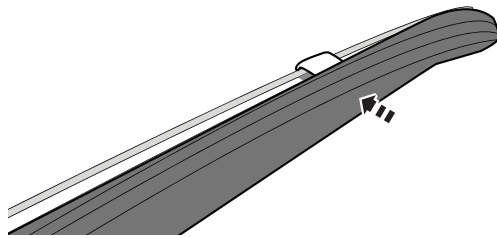

29

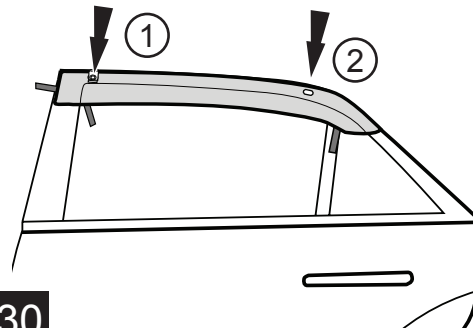

30

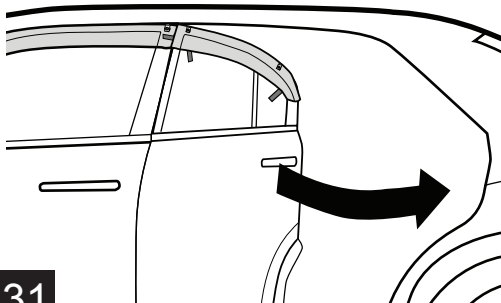

31

Lift visor slightly away from vehicle to assist with tape removal.

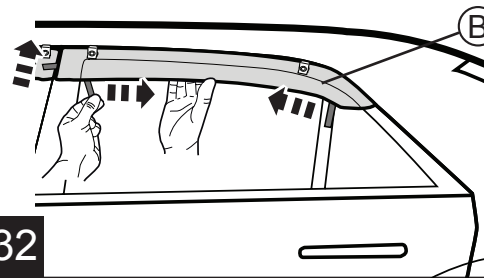

32



GENUINE ACCESSORIES

Apply firm even pressure for 30 seconds.

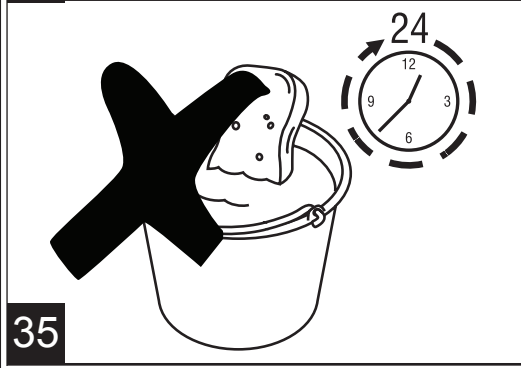
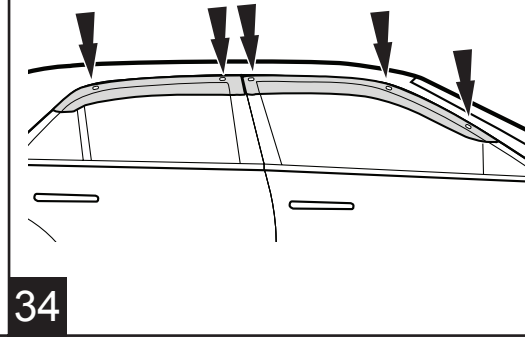
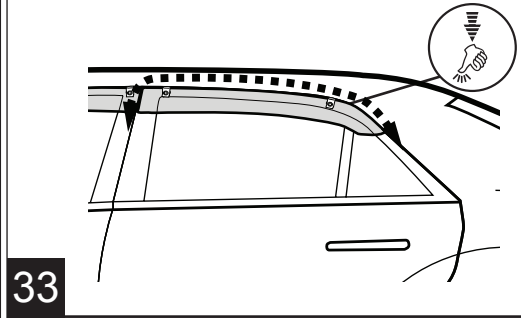



CHRYSLER 300

Défecteurs latéraux pour vitres

ACCESSOIRES AUTHENTIQUES

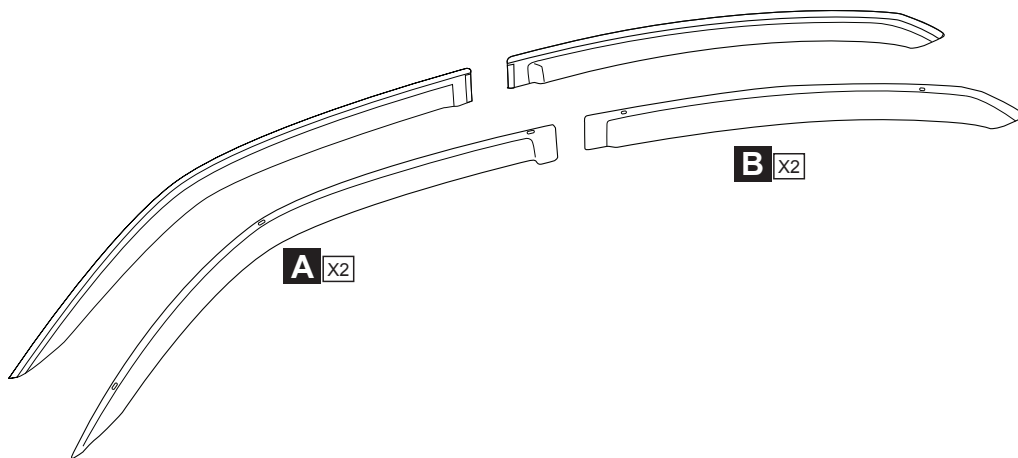

C X2



D X8



E X8

F

NOTICE DE MONTAGE

Ne pas monter les pièces avant l'enregistrement du véhicule.

PARE-SOLEIL DE PORTE

Subject to alteration without notice
Reservadas modificaciones técnicas
Sous réserve de modifications techniques

Expert Fitment Required
Montaje sólo por el concesionario
Montage par spécialiste nécessaire



ACCESSOIRES AUTHENTIQUE

<p>1</p>	<p>2</p>
<p>3</p>	<p>4</p>
<p>5</p>	<p>6</p>
<p>7</p>	<p>8</p>



ACCESSOIRES AUTHENTIQUE

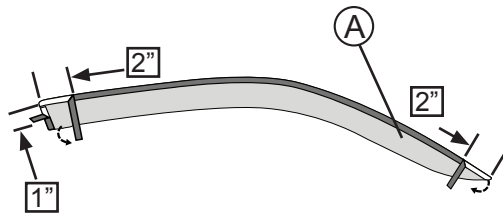

9

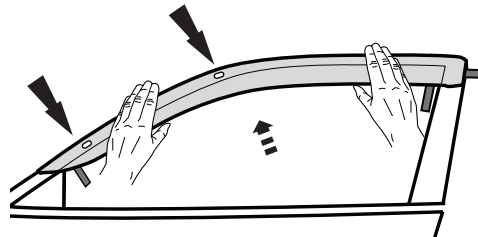

10

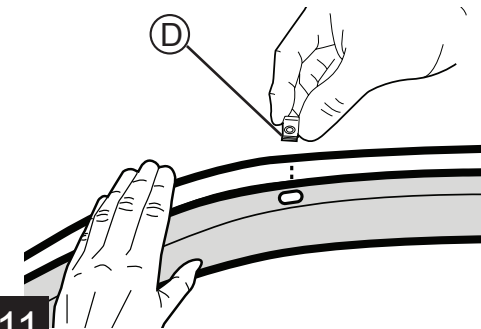

11

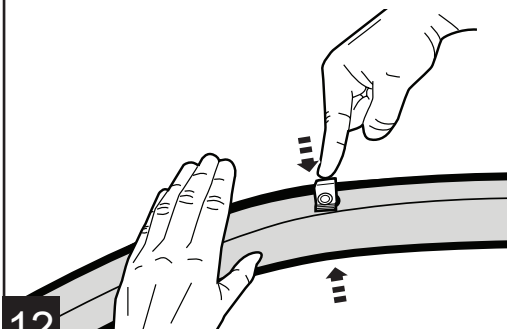

12

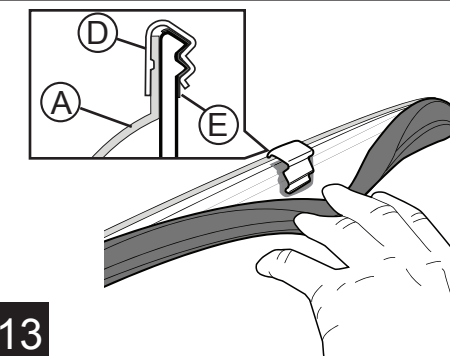

13

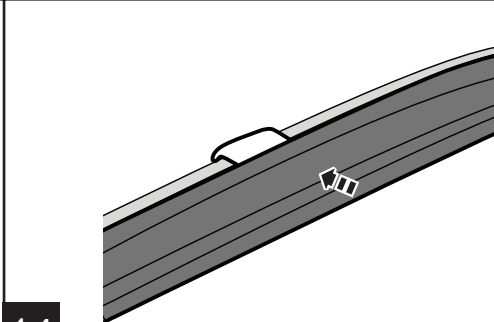

14

Reportez-vous à l'étape 19 pour un placement correct.

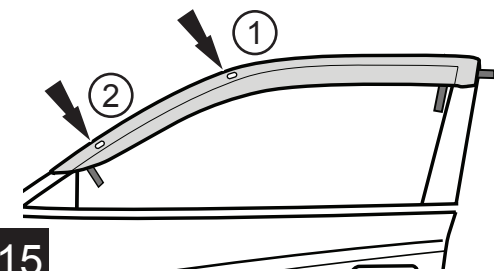

15

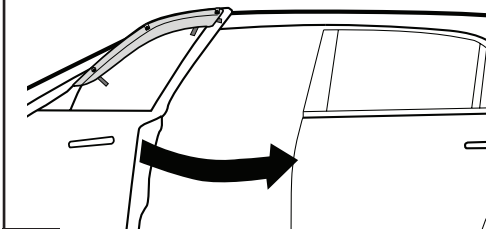

16



ACCESSOIRES AUTHENTIQUE

Ascenseur visière légèrement à l'écart du véhicule pour aider à l'enlèvement de bande.



17

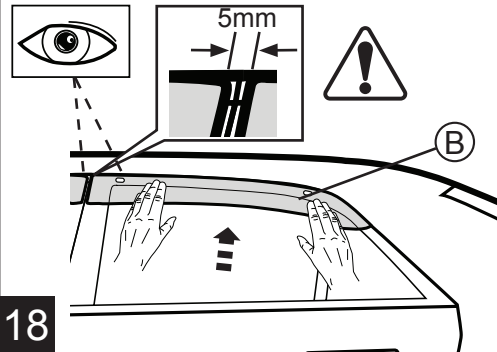

18

Faire pression uniformément pendant 30 secondes.

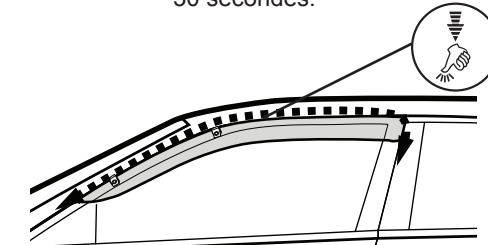

19

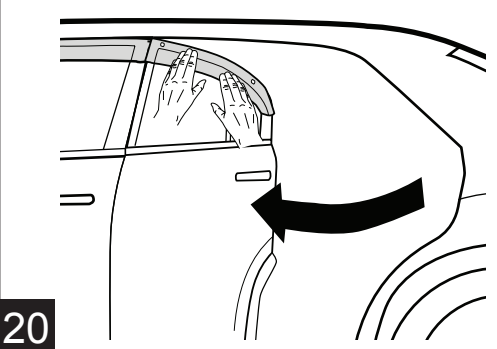

20

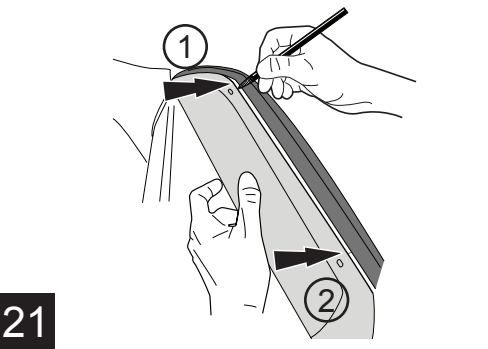

21

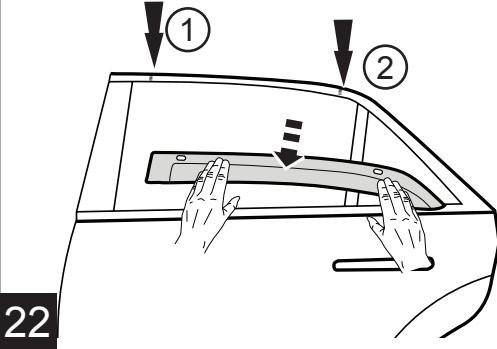

22

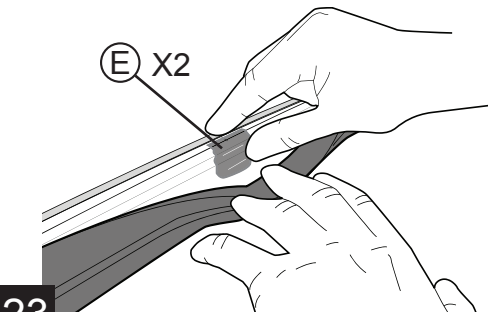

23

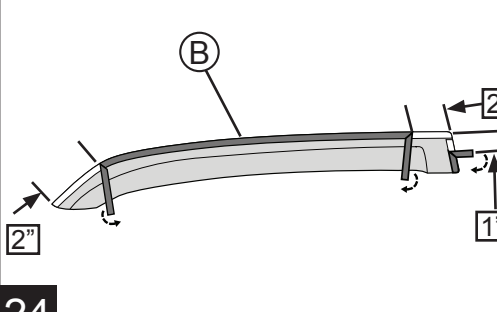

24



ACCESSOIRES AUTHENTIQUE

Reportez-vous à l'étape 19 pour un placement correct.

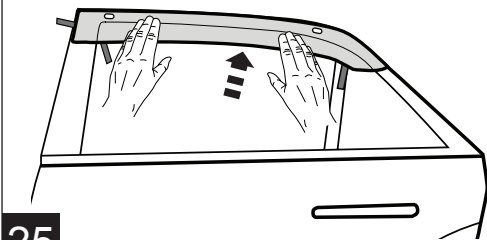

25

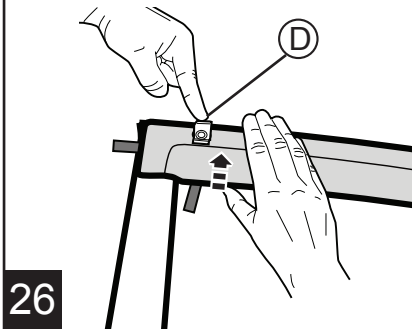

26

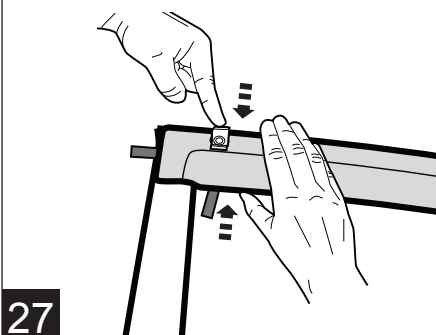

27

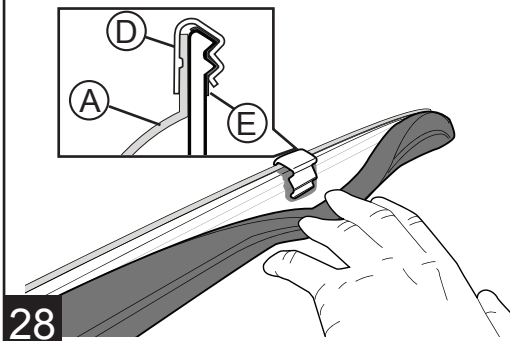

28

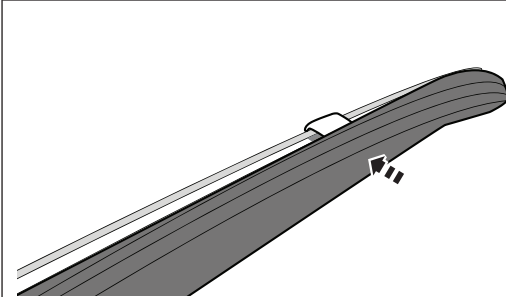

29

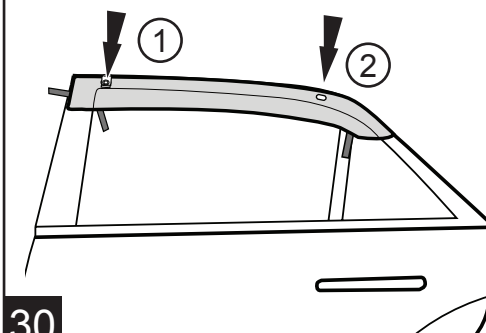

30

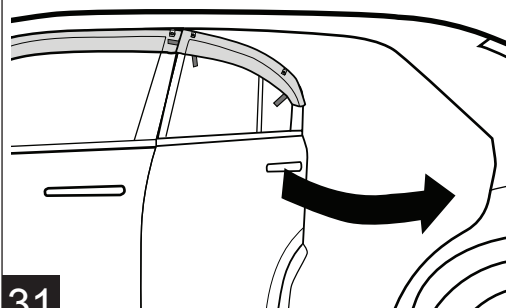

31

Ascenseur visière légèrement à l'écart du véhicule pour aider à l'enlèvement de bande.

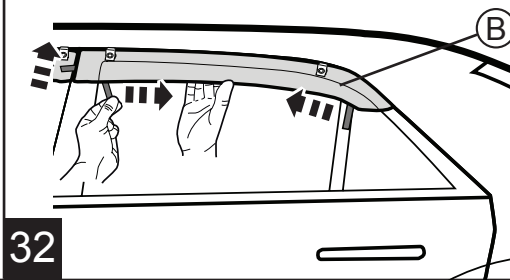

32



ACCESSOIRES AUTHENTIQUE

Faire pression uniformément pendant 30 secondes.

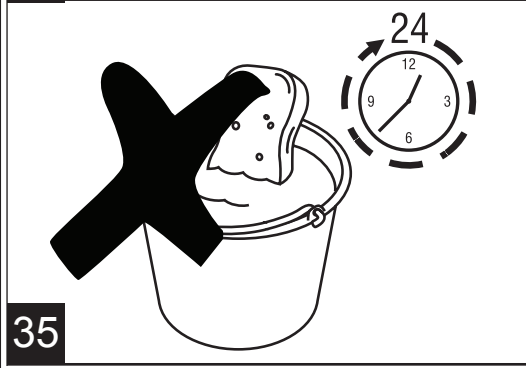
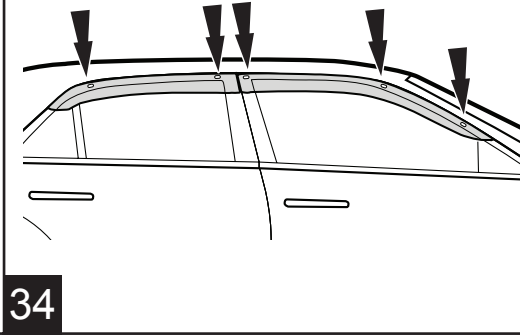
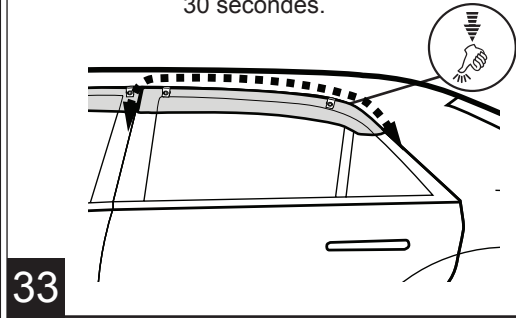



CHRYSLER 300

Deflectores para ventana lateral

ACCESORIOS ORIGINALES

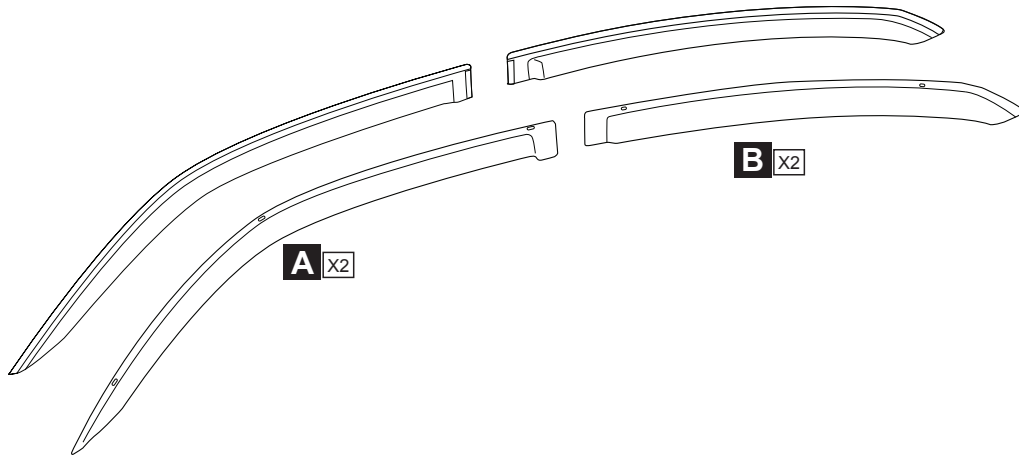

C X2



D X8



E X8

E

INSTRUCCIONES DE MONTAJE

No se permite montar las piezas antes de registrar el vehículo.

VISORES DE PUERTA

Subject to alteration without notice
Reservadas modificaciones técnicas
Sous réserve de modifications techniques

Expert Fitment Required
Montaje sólo por el concesionario
Montage par spécialiste nécessaire



ACCESORIOS ORIGINALES

<p>105° F — 40° C 60° F — 20° C ✓</p>	<p>2</p>
<p>3</p>	<p>4</p>
<p>5</p>	<p>6</p>
<p>7</p>	<p>8</p>



ACCESORIOS ORIGINALES

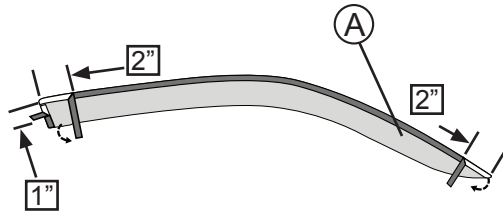

9

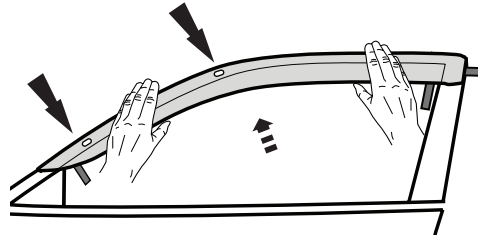

10

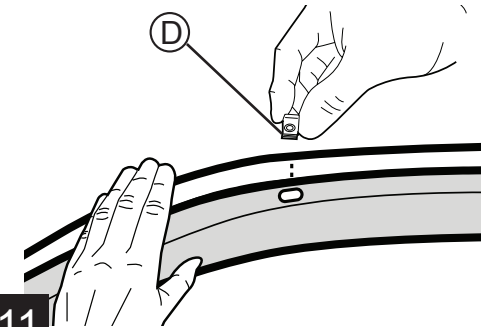

11

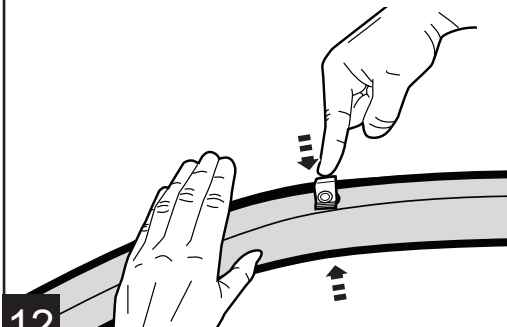

12

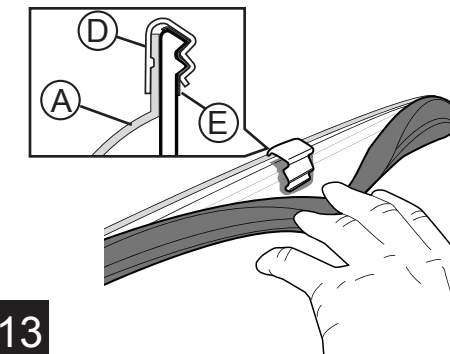

13

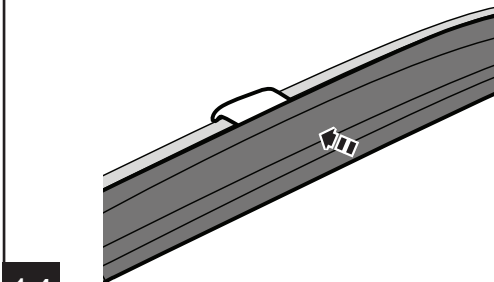

14

Consulte el paso 19 para su correcta colocación.

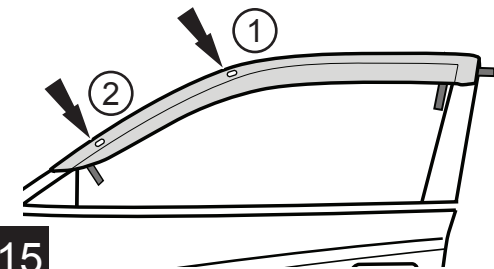

15

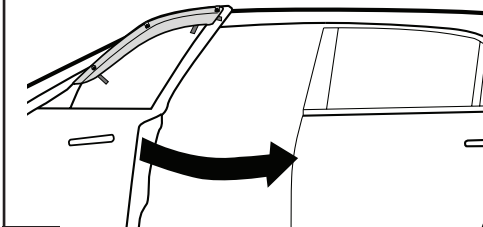

16



ACCESORIOS ORIGINALES

Levantar la visera un poco lejos del vehículo para ayudar con la eliminación de la cinta.

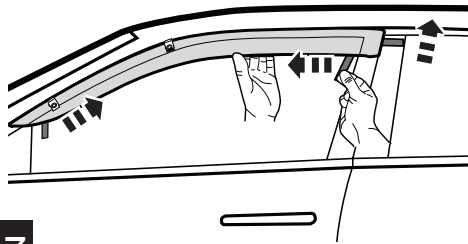

17

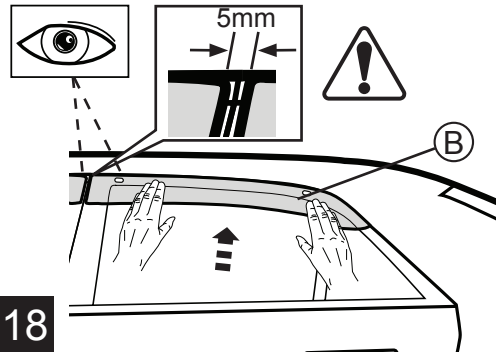

18

Presione de manera firme y pareja durante 30 segundos.

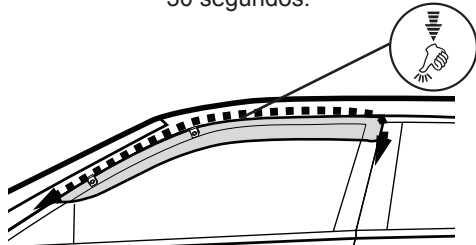

19

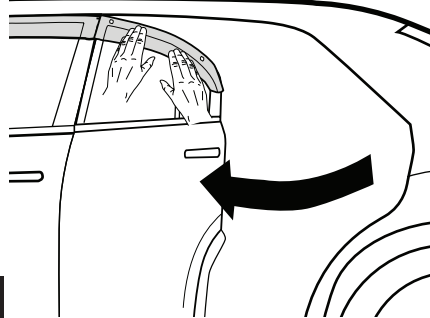

20

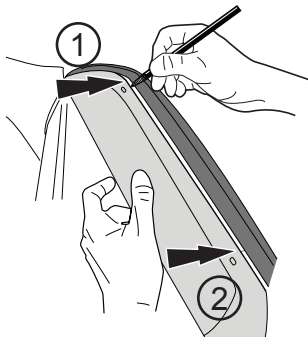

21

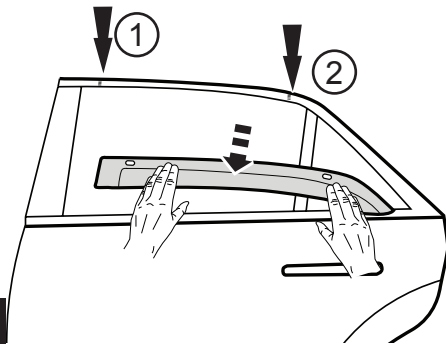

22

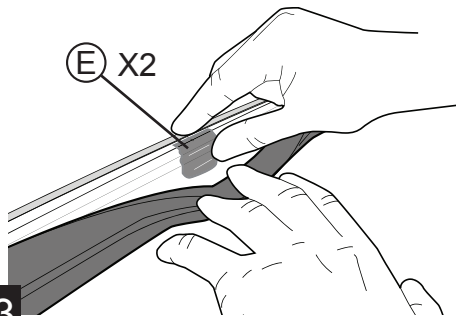

23

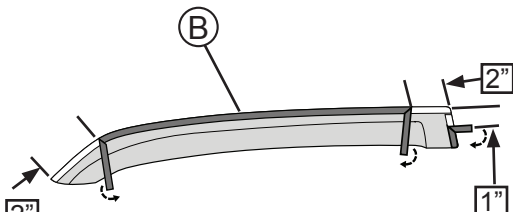

24



ACCESORIOS ORIGINALES

Consulte el paso 19 para su correcta colocación.

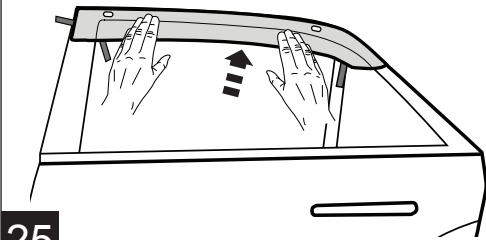

25

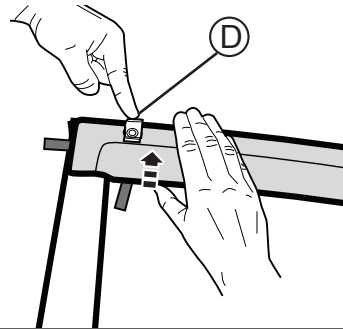

26

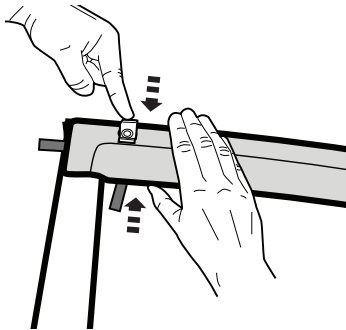

27

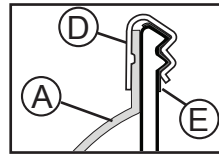

28

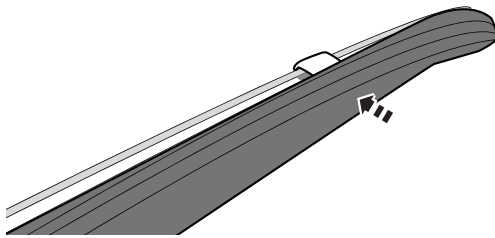

29

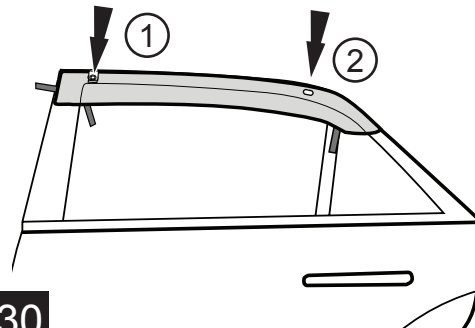

30

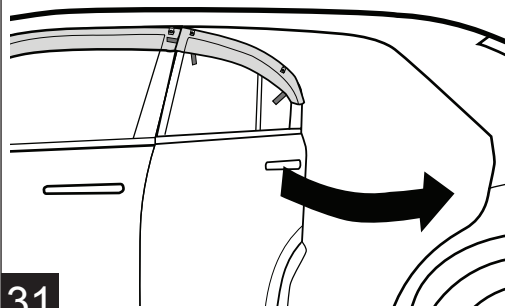

31

Levantarse la visera un poco lejos del vehículo para ayudar con la eliminación de la cinta.

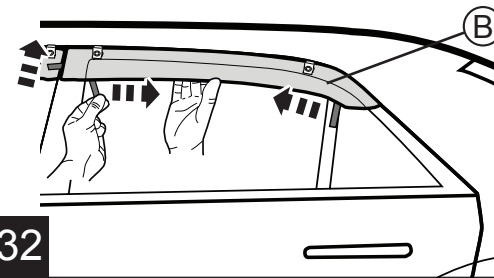

32



ACCESORIOS ORIGINALES

Presione de manera firme y pareja durante 30 segundos.

