

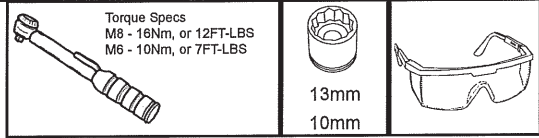

RAM SIDE STEP
ESTRIBO RAM
MARCHEPIED DE RAM

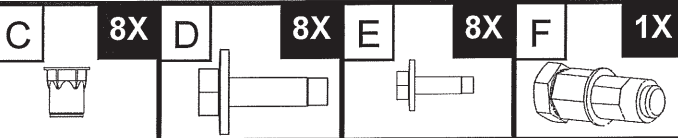
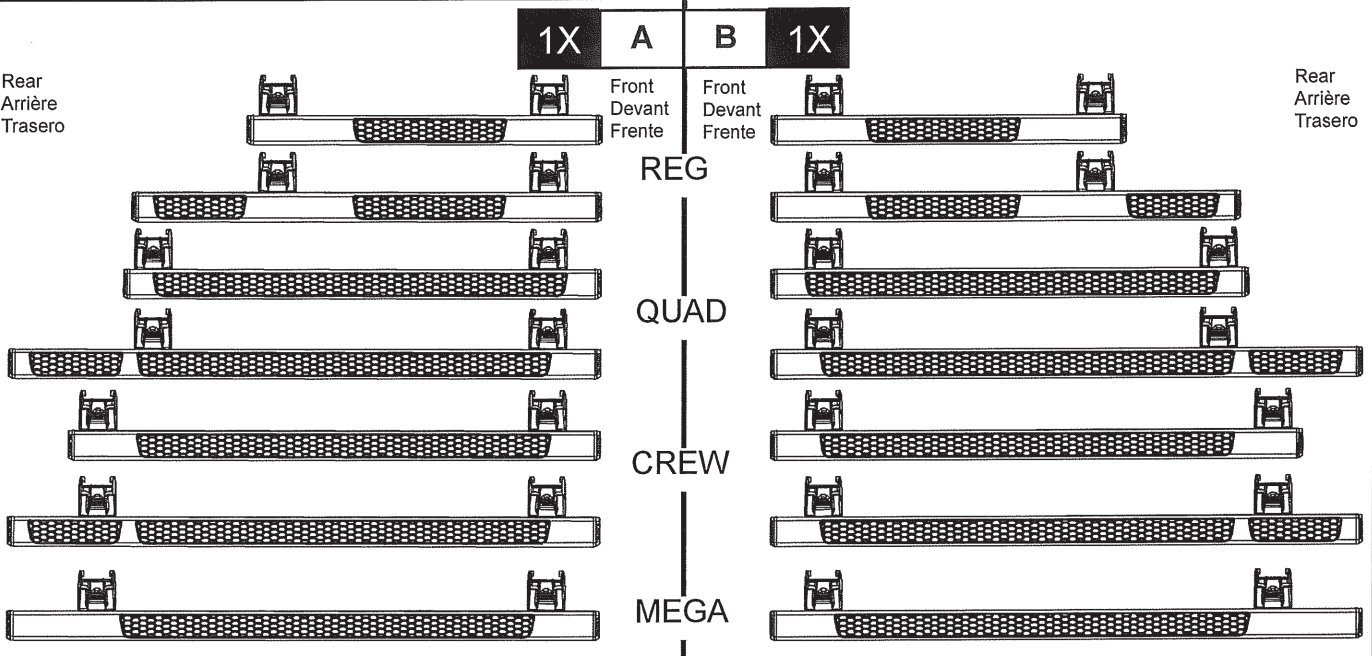

Lubricate the riv-nut tool using fresh motor oil for lubricant and clean rivnut threads with brake cleaner after installed on vehicle.

Apply 25Nm +/-1.5Nm of torque to the riv-nut tool. If a torque wrench is not available rotate the riv-nut tool for 3.5 turns +/- 0.25 turn to ensure riv-nut is fully collapsed.

Important: Upon installation riv-nut flange should be flat and tight to the sheet metal. Riv-nut should not have any slack.

Caution: Use riv-nut tool pt# 82212003 to properly install riv-nuts. Do not use any other method to collapse riv-nuts.

1 Re-lubricate the riv-nut tool before installing every rivnut.

FRONT OF VEHICLE
DEVANT DU VEHICULE
PARTE DELANTERADEL VEHICULO

SOME VEHICLES MAY HAVE PRE-INSTALLED WELD-NUTS IN FRAME AND DO NOT REQUIRE RIVNUTS. DISCARD EXTRA IF NECESSARY

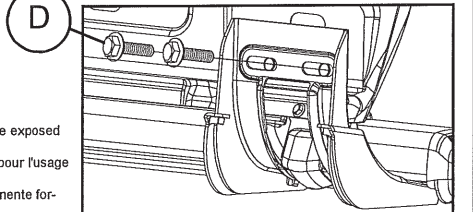
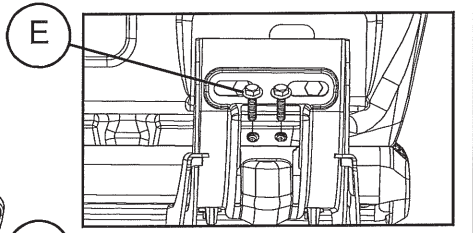
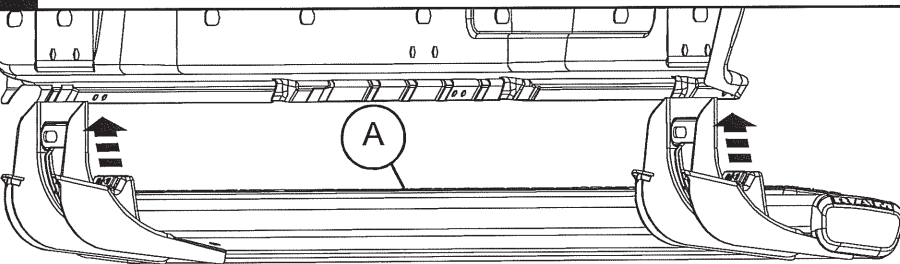
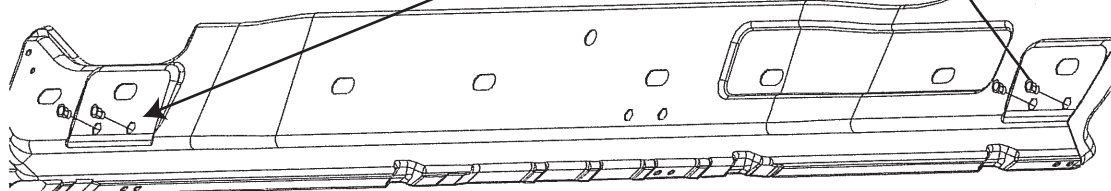

Warning: This side step reduces your vehicle's ground clearance. It is not intended for off-road use.
La advertencia: Este paso del lado reduce el espacio libre del suelo de su vehículo. No es pensado para el uso todoterreno.
Avertissement : Cette étape latérale réduit le dégagement du sol de votre véhicule. Il n'est pas voulu pour l'usage tout-terrain.

Care: Chrome Cleaner - Excellent chrome surfaces cleaner. Ideally suited for all bright metals. Specifically formulated for use on surfaces that are exposed to weather or water. Part No. 04318013
Soin : Le Nettoyeur chromé - le chrome Excellent apparaît le nettoyeur. Idéalement adapté pour tous les métaux brillants. En particulier formulé pour l'usage sur les surfaces qui sont exposés pour l'eau ou temps. Part No. 04318013
El cuidado: Crome Limpiador - Excelente limpiador de superficies de cromo. Idealmente convenido para todos los metales brillantes. Especificamente formulado para el uso en superficies que son expuestas de capear o regar. Part No. 04318013

2



RAM WHEEL TO WHEEL SIDE STEP
 ESTRIBO RUEDA DE RUEDA RAM
 MARCHPIED UNE ROUE À L'AUTRE RAM

MOPAR®

		1X	A	B	1X		
Rear Arrière Trasero		Front Devant Frente		Front Devant Frente			Rear Arrière Trasero
		CREW					
		MEGA					
C	12X	D	12X	E	12X	F	1X
		Torque Specs M8 - 16Nm, or 12FT-LBS M6 - 10Nm, or 7FT-LBS				13mm 10mm	

Lubricate the riv-nut tool using fresh motor oil for lubricant and clean rivnut threads with brake cleaner after installed on vehicle.

Apply 25Nm +/-1.5Nm of torque to the riv-nut tool. If a torque wrench is not available rotate the riv-nut tool for 3.5 turns +/- 0.25 turn to ensure riv-nut is fully collapsed.

Important: Upon installation riv-nut flange should be flat and tight to the sheet metal. Riv-nut should not have any slack.

Caution: Use riv-nut tool pt# 82212003 to properly install riv-nuts. Do not use any other method to collapse riv-nuts.

Re-lubricate the riv-nut tool before installing every rivnut.

FRONT OF VEHICLE
 DEVANT DU VEHICULE
 PARTE DELANTERA DEL VEHICULO

SOME VEHICLES MAY HAVE PRE-INSTALLED WELD-NUTS IN FRAME AND DO NOT REQUIRE RIVNUTS. DISCARD EXTRA IF NECESSARY

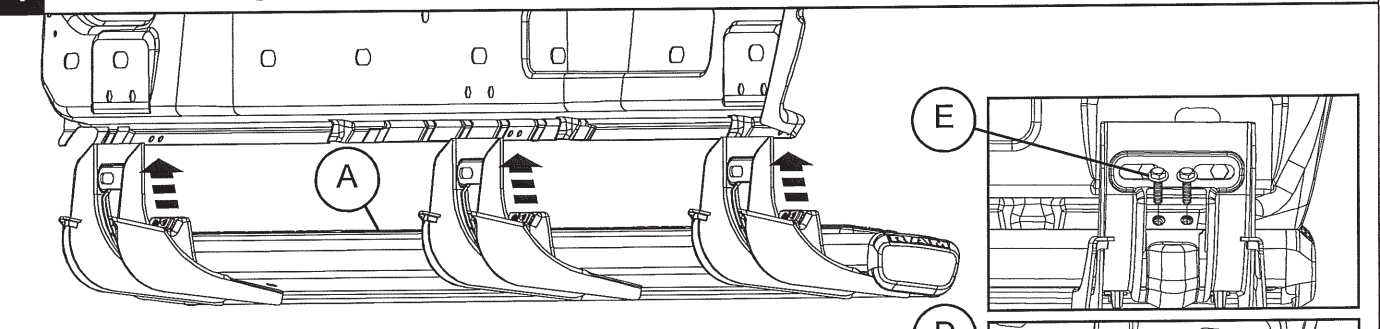
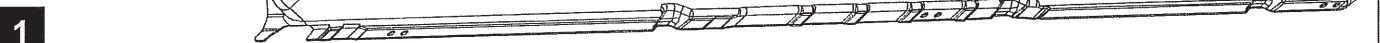

Warning: This side step reduces your vehicle's ground clearance. It is not intended for off-road use.
 La advertencia: Este paso del lado reduce el espacio libre del suelo de su vehículo. No es pensado para el uso todoterreno.
 Avertissement: Cette étape latérale réduit le dégagement du sol de votre véhicule. Il n'est pas voulu pour l'usage tout-terrain.

Care: Chrome Cleaner - Excellent chrome surfaces cleaner. Ideally suited for all bright metals. Specifically formulated for use on surfaces that are exposed to weather or water. Part No. 04318013
 Soin: Le Nettoyeur chromé - le chrome Excellent apparaît le nettoyeur. Idéalement adapté pour tous les métaux brillants. En particulier formulé pour l'usage sur les surfaces qui sont exposés pour l'eau ou temps. Part No. 04318013

El cuidado: Cromo Limpiador - Excelente limpiador de superficies de cromo. Idealmente convenido para todos los metales brillantes. Específicamente formulado para el uso en superficies que son expuestas de cepear o regar. Part No. 04318013

