



# CHRYSLER PACIFICA

Front Side Window Deflectors

Deflector de ventana lateral

Déflecteur de la glace latérale

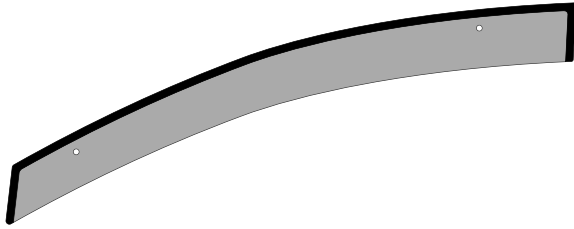

**A** 1x

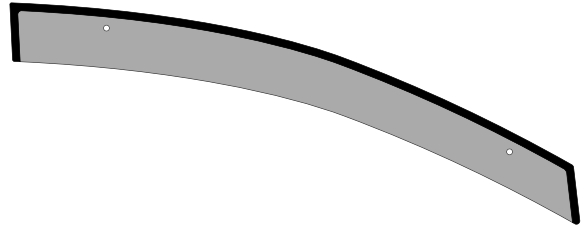

**B** 1x



**C** 2x

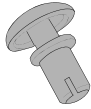

**D** 4x

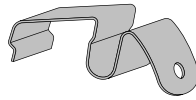

**E** 4x

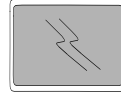

**F** 4x

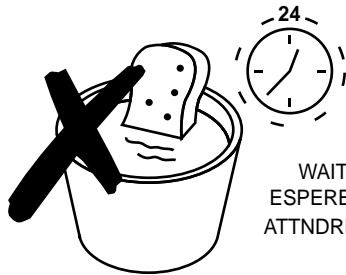
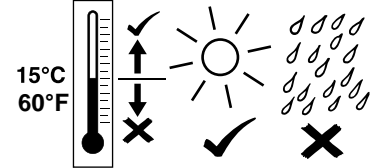

WAIT 24 HOURS BEFORE WASHING VEHICLE  
ESPERE 24 HORAS ANTES DE LAVAR EL VEHÍCULO  
ATTNDRE 25 HEURES AVANT DE LAVER LE VÉHICULE

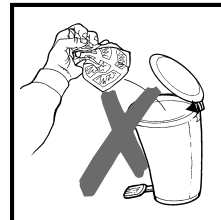
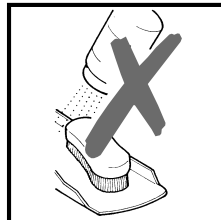
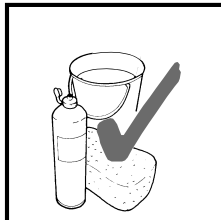
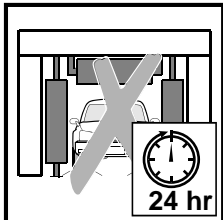

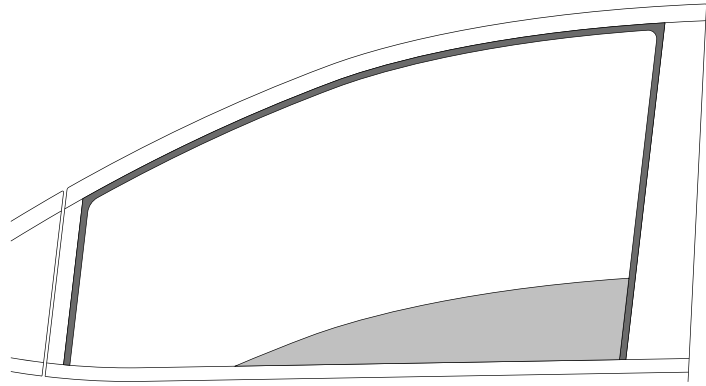
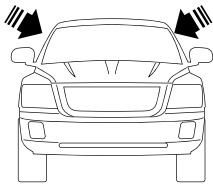
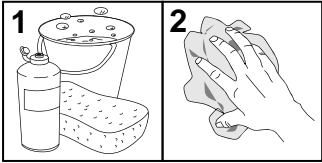

1

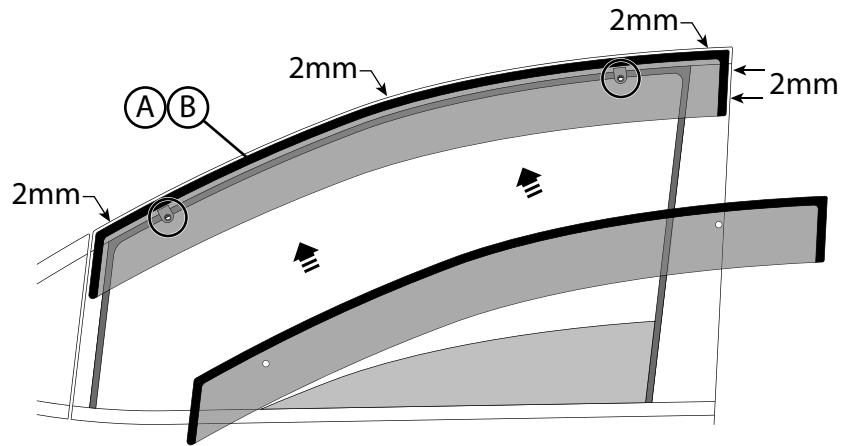
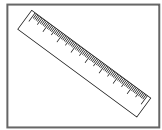
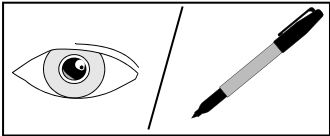

2

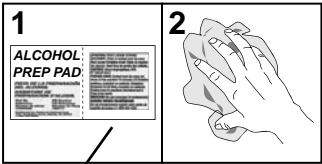

C

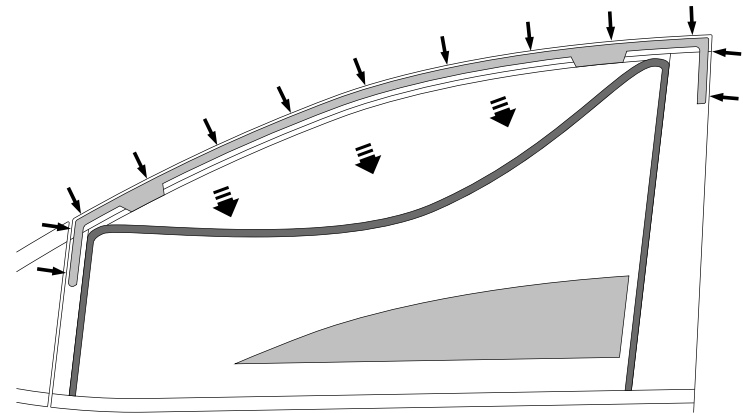

3

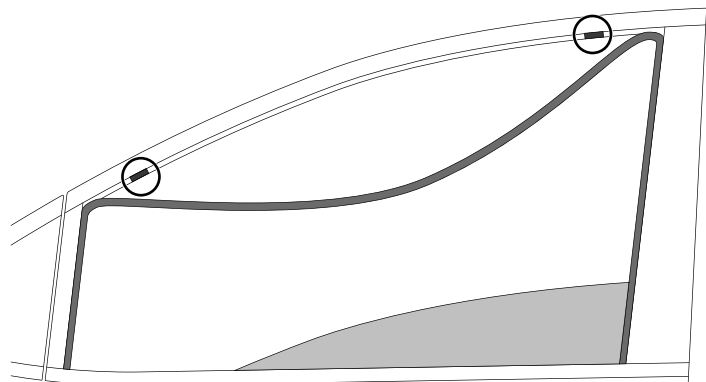
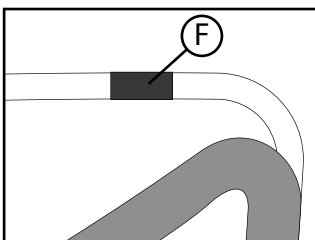
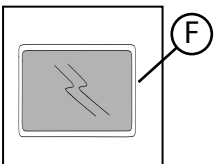

4

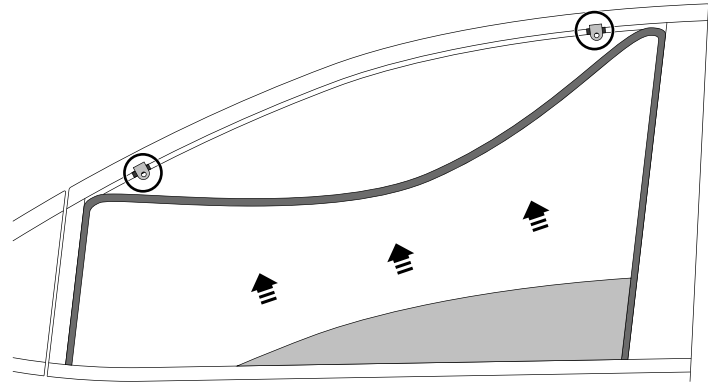
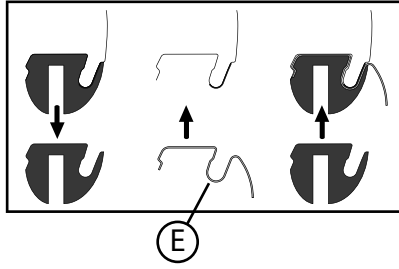
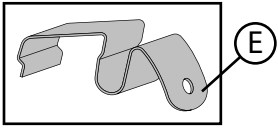

5

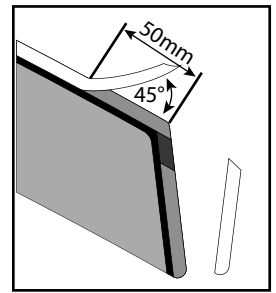
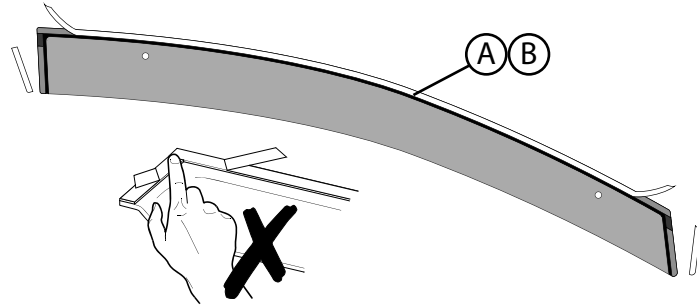
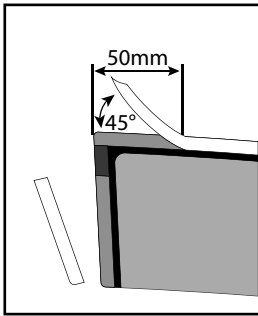

6

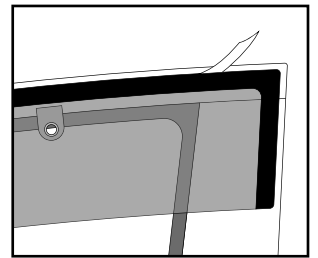
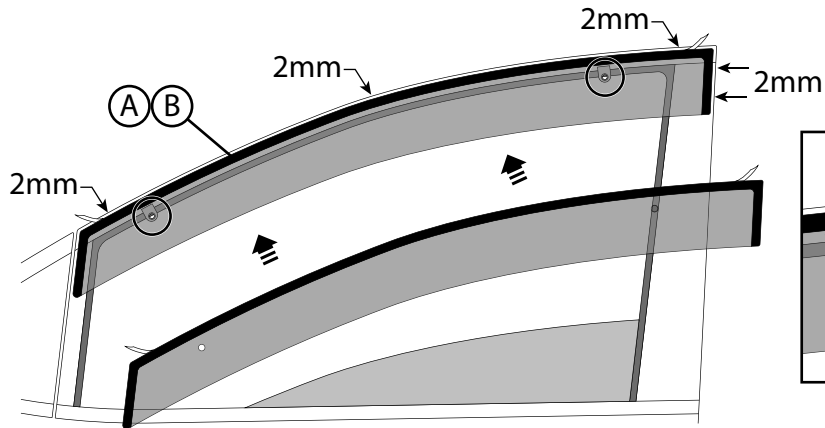
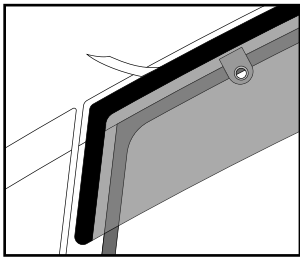

7

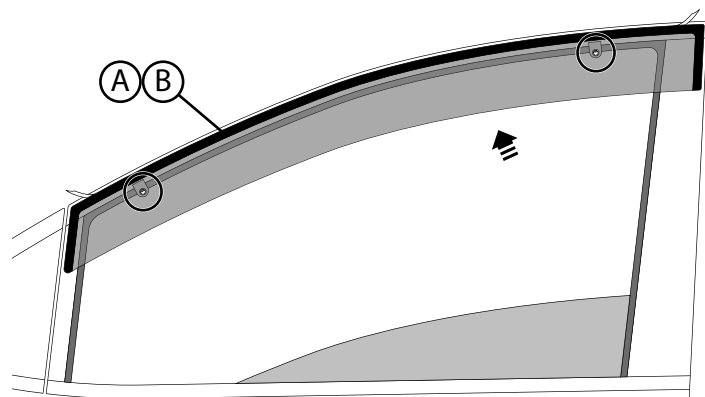
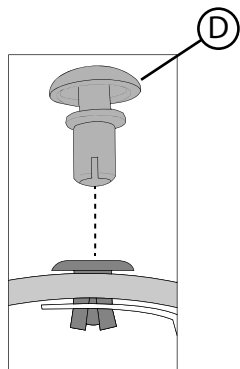
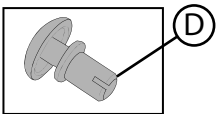

8

9

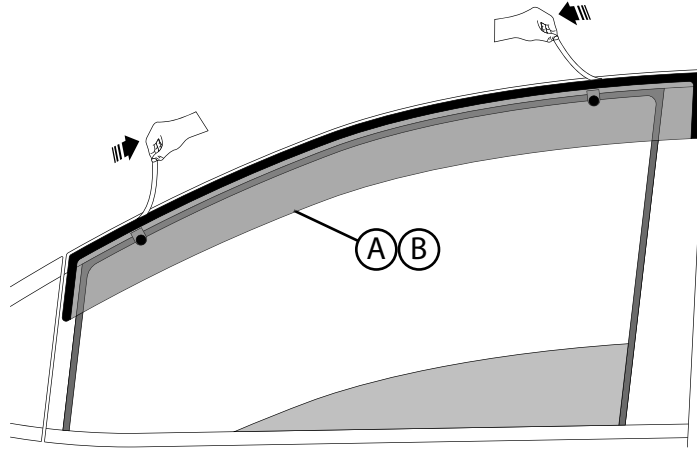

APPLY FIRM EVEN PRESSURE FOR 30 SECONDS  
APLIQUE PRESIÓN FIRME Y UNIFORME DURANTE 30 SEGUNDOS  
APPLIQUER DE LA PRESSION FERME ET ÉGALE PENDANT 30 SECONDES

10

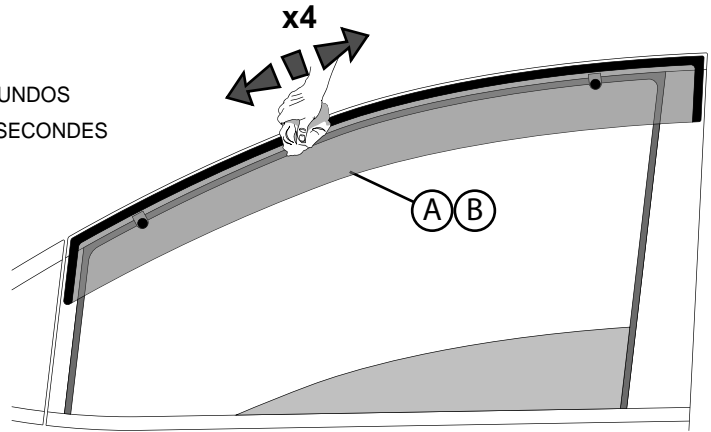

CYCLE WINDOWS OPEN/CLOSED AT LEAST 5 TIMES TO ENSURE SEAL IS INSTALLED PROPERLY  
REALICE CICLOS CON LAS VENTANAS ABIERTAS Y CERRADAS DURANTE AL MENOS 5 VECES PARA  
OUVRIR ET FERMER LES FENÊTRES AU MOINS 5 AFIN DE VÉRIFIER SI LE DISPOSITIF D'ÉTANCHÉITÉ  
EST BIEN INSTALLÉ

11

