



Installation Instructions
Dodge Challenger SRT®
Dodge Challenger SRT® Demon
Rear Seat Delete Kit



www.mopar.com

Bill of Materials

82215917**: Dodge Challenger SRT Rear Seat Delete Kit			
Item #	Part Number	Part Description	Qty
1	68316996AB ³	Bracket (for Back Panel)	1
2	6EQ86DX9**	Cap/Cover Trim-Right (Upper Qtr Trim)	1
3	6EQ87DX9**	Cap/Cover Trim -Left (Upper Qtr Trim)	1
4	K6862965	Mopar Installation Instructions	1
5	6EQ84DX9AC ³	Back Panel	1
6	06030441	Push Pin (for Rear Package Shelf)	2
7	06502064	Screws (for Bracket-Back Panel)	2
8	6EQ88DX9AB ³	Rear Package Shelf	1
9	6RP40DX9AA ³	Lower panel (Dodge Challenger)	1

Bill of Materials

82215918**: Dodge Challenger SRT Demon Rear Seat Delete Kit			
Item #	Part Number	Part Description	Qty
1	68316996AB ³	Bracket (for Back Panel)	1
2	6EQ86DX9**	Cap/Cover Trim-Right (Upper Qtr Trim)	1
3	6EQ87DX9**	Cap/Cover Trim -Left (Upper Qtr Trim)	1
4	K6862965	Mopar Installation Instructions	1
5	6EQ84DX9AC ³	Back Panel	1
6	06030441	Push Pin (for Rear Package Shelf)	2
7	06502064	Screws (for Bracket-Back Panel)	2
8	6EQ88DX9AB ³	Rear Package Shelf	1
10	6EQ85DX9AB ³	Lower panel (Dodge Demon)	1

Item 1 – Bracket:



Item 2 & 3 – Caps L&R:



Item 4 -
Instructions:



Item 5 – Back Panel:



Item 6 –
Push Pin 2X:



Item 7 –
Screw 2X:



Item 8– Rear Package Shelf:



Item 9 - Dodge Challenger SRT Lower Panel

- OR -

Item 10 – Dodge Challenger SRT Demon Lower Panel:

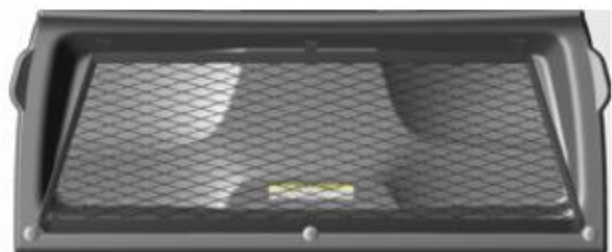

1. Using hand pressure, lift and pull the Seat Cushion front edge. Pull up to disengage the (2) outboard attachments to the floorplan. Discard the Seat Cushion.

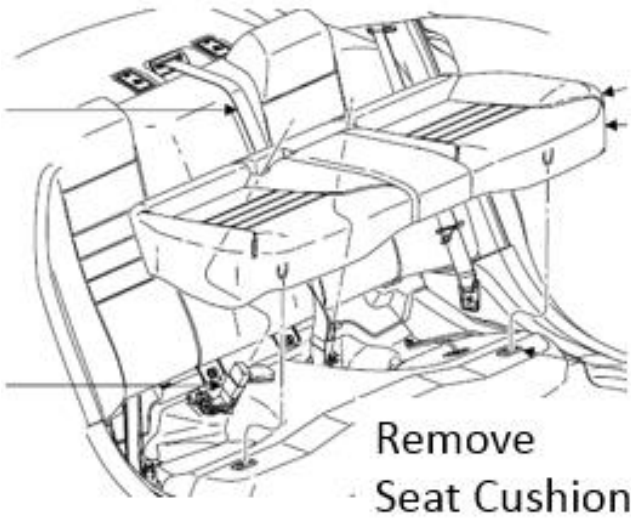

2. At the bottom of the Lower Quarter Trim Panels (left and right hand), remove the bolts for the Seat Belt Webbing (left and right hand). Pull the Seat Belt Webbing out of the slots. Discard the bolts.

Tools Required:

Bit Holder: 1/2 IN. FEMALE SQ. DR. Bit: PWR-TORXTYPE T-50 3 1/2 IN. LG.



3. Remove the nuts for the Seat Belt Buckle Assemblies (left and right hand). Pull the Seat Belt Buckle Assemblies out of the slots. Discard Seat Belt Buckles and nuts.

Tools Required:

Socket Wrench: CS 18MM-12P-3/8"L

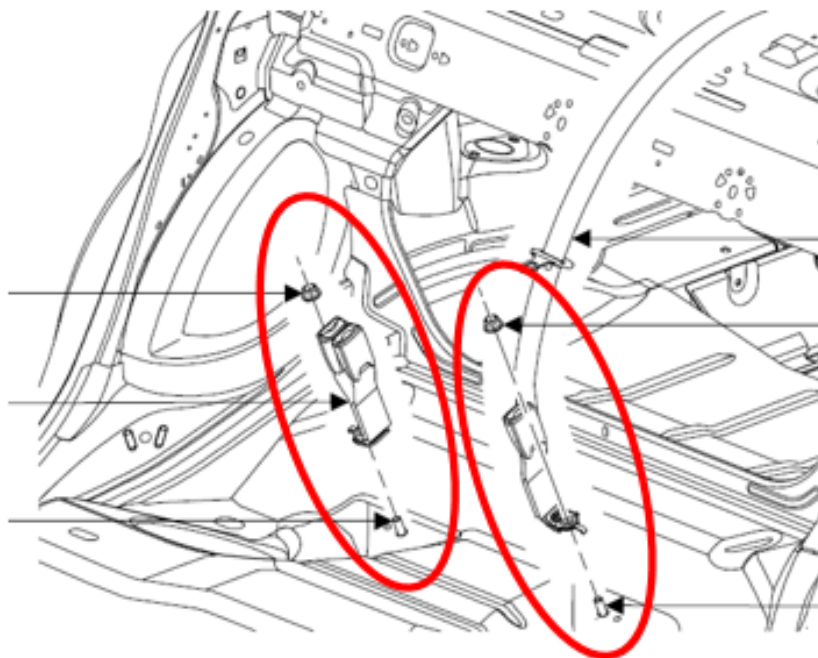



4. Fold the 60/40 Seat Back in the down position. Remove (5) nuts in the locations shown below. Remove and discard the 60/40 Seat Back and nuts.

Tools: Required:

Socket Wrench: CS 18MM-12P-3/8" L

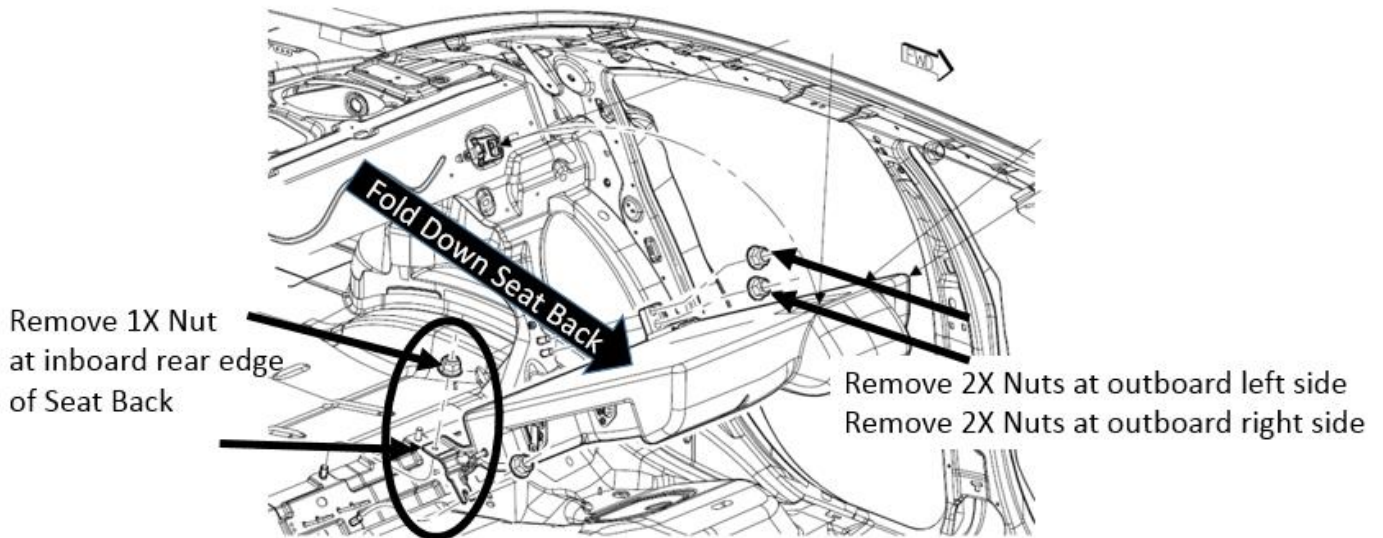



5. Unsecure the Upper Quarter Trim Panels (left and right hand) by removing the SRS Label Cap. Reach through opening with a 7mm socket wrench and unscrew part from vehicle. Retain the SRS Label Caps for reuse in step #10. Partially remove Upper Quarter Trim Panels (left and right hand) to gain access to the Seat Belt Retractor. Partially remove Lower Quarter Trim Panel in area of Rear Package Shelf location by removing the push pins (left and right hand). Retain the push pins for reuse in step #10. Remove the Seat Belt Retractor Bolts (left and right hand) and discard. Remove the Seat Belt Web Guide Bolts (left and right hand) and discard. Feed the Seat Belt Webbing through Upper Quarter Trim Panel. Discard the Seat Belt. Remove the C-pillar Trim Panels and disengage the tether clips (left and right hand). Retain C-pillars Trim Panels for reuse in step #10.

Tools Required:

Socket Wrench: 7mm

Bit Holder: HEX INSERT 1/4IN HEX X 3/8 SQ. DR

Bit: 1/4 IN. DR. PHILLIPS TYPE SIZE 2 X 1IN. LG and Bit T-50 3 1/2 IN.



Remove SRS Label Cap left and right hand

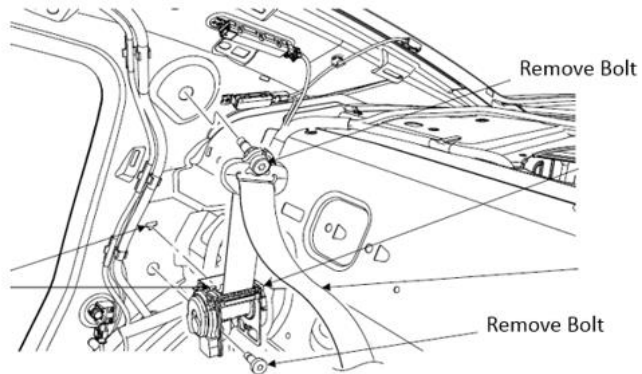

Remove upper and lower bolts to unsecure Seat Belt Web Guide and Retractor left and right hand

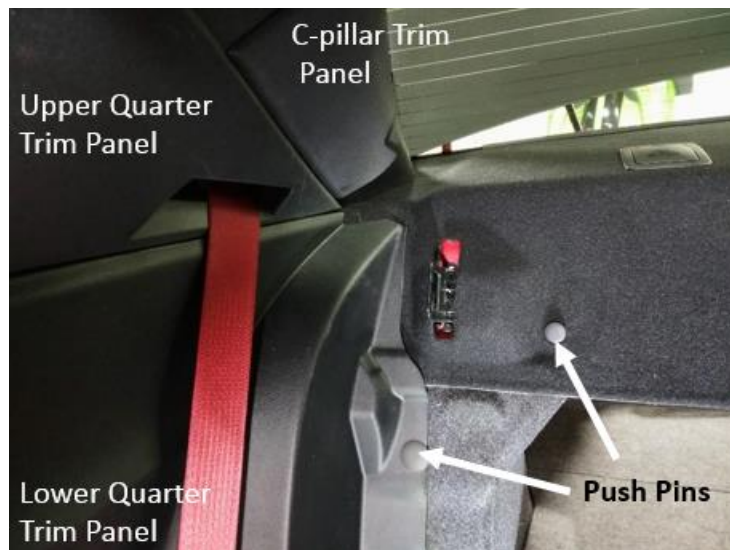

6. Remove the push pins from the original Rear Package Shelf. Feed the Center Seat Belt Retractor Webbing through the Rear Package Shelf slot to access to the Center Seatbelt Retractor top attachment location. Remove the nut from the Seat Belt Center Retractor. Discard the Rear Package Shelf and the Center Seat Belt retractor, webbing, and nut.

Tools Needed:

Socket Wrench: 18mm – 12P – 3/8" L

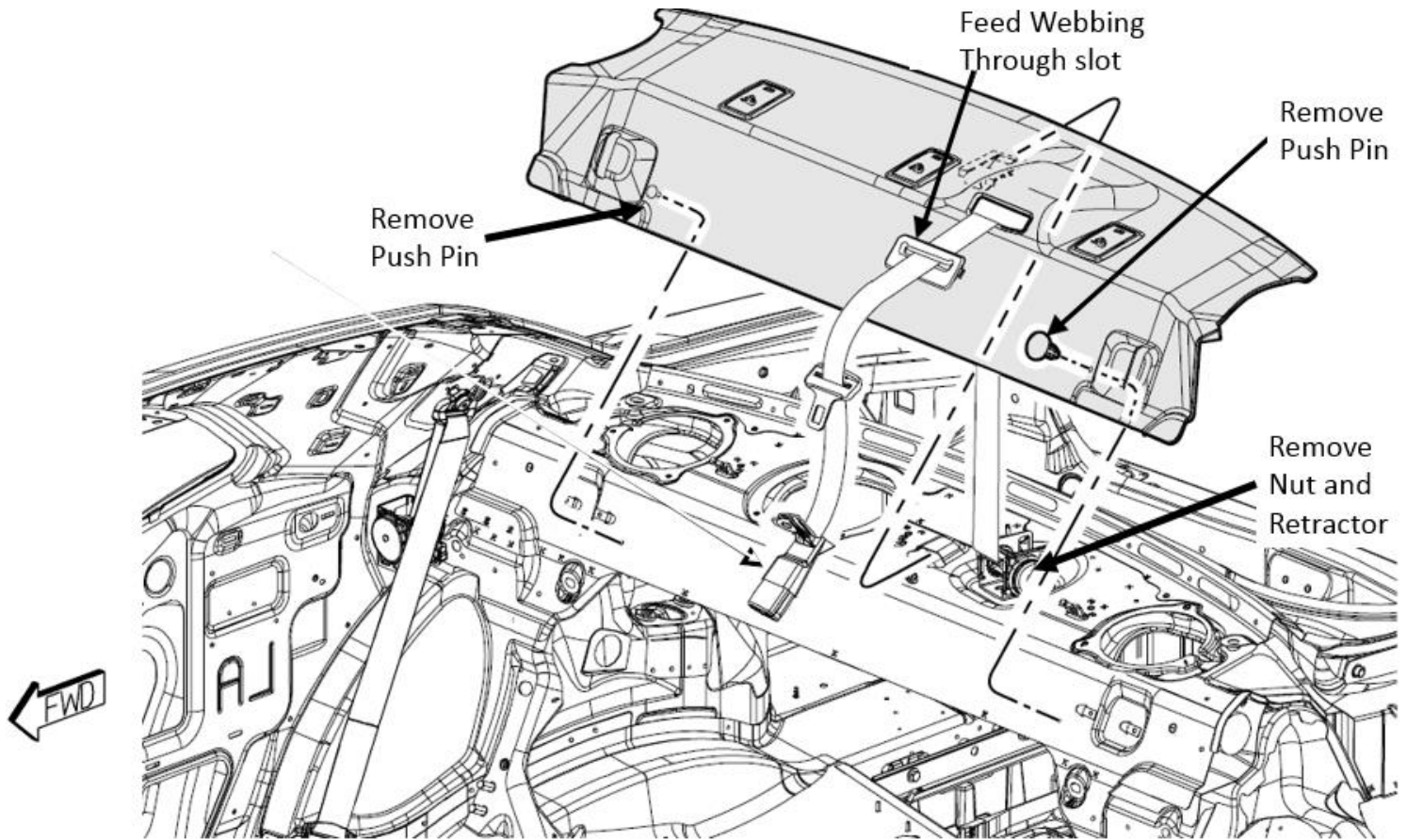

7. Remove the Striker Assemblies (left and right hand) and bolts. Discard strikers and bolts.

Tools Required:

Socket Wrench: 10MM- 6P-3/8"L

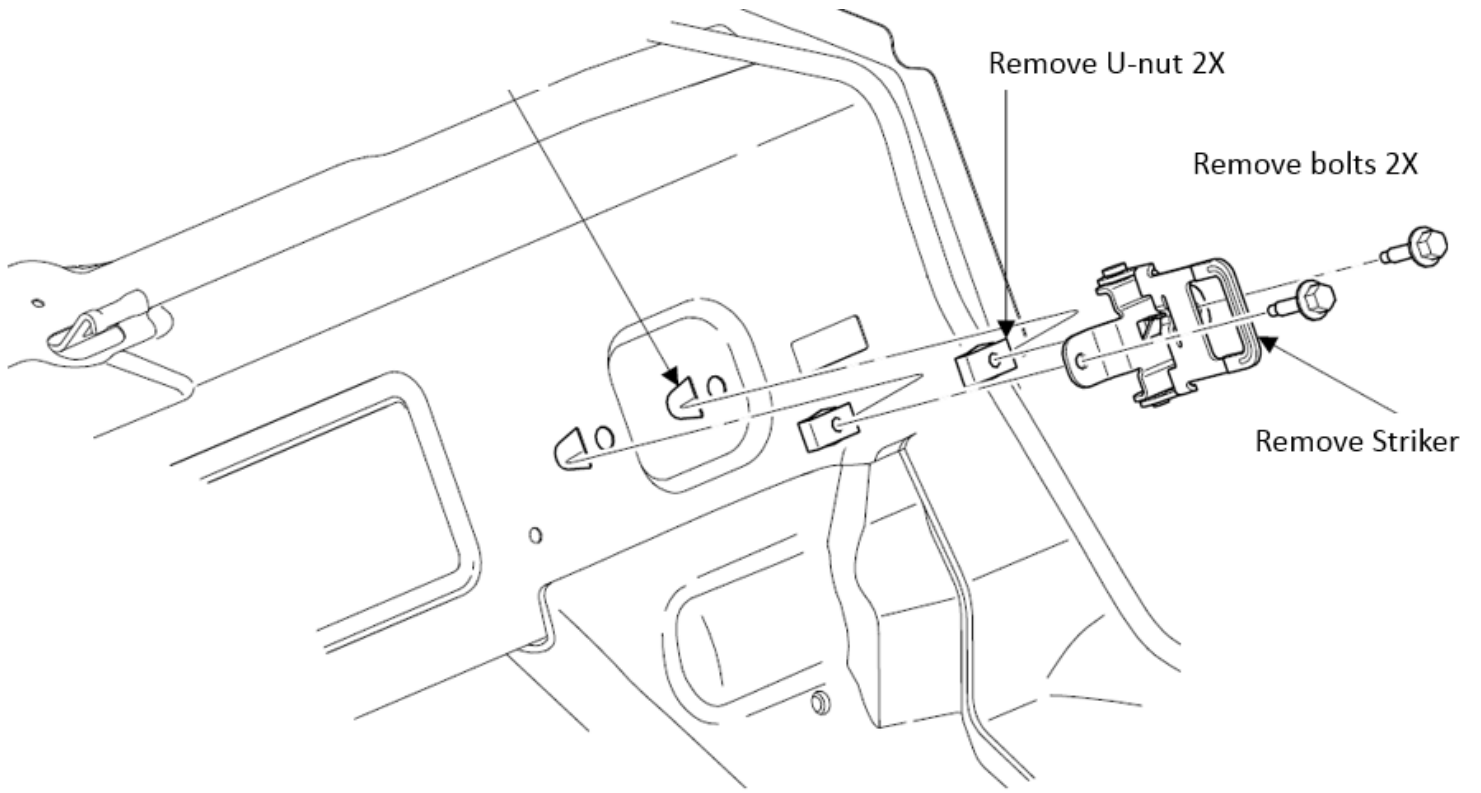

8. Position the **new Rear Package Shelf** to body. Engage metal clips (attached to the Rear Package Shelf) to the formation on the body. Install the (2) **new Push Pins** in the positions as shown:

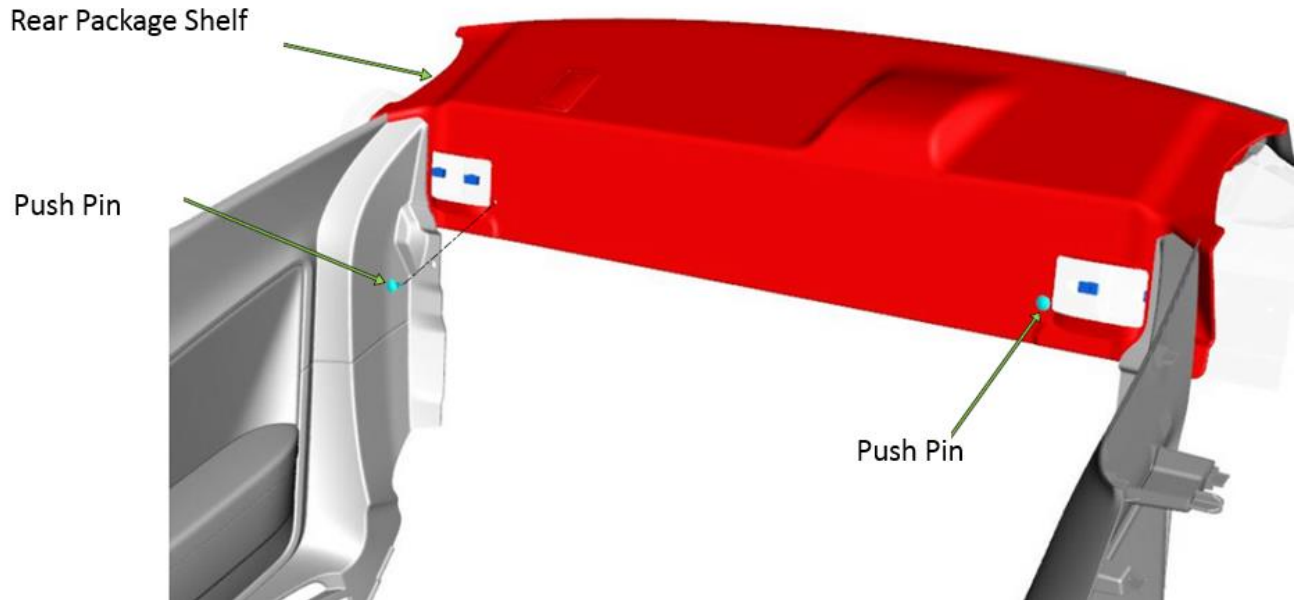

9. Locate the **new Bracket** to the seat back area with slotted hole on the left hand side. Obtain the (2) **new Screws** and fasten the right hand screw into the fixed hole, then fasten the left hand screw into the slotted hole.

Tools Required:

Socket Wrench: 10mm, 6-10 Nm

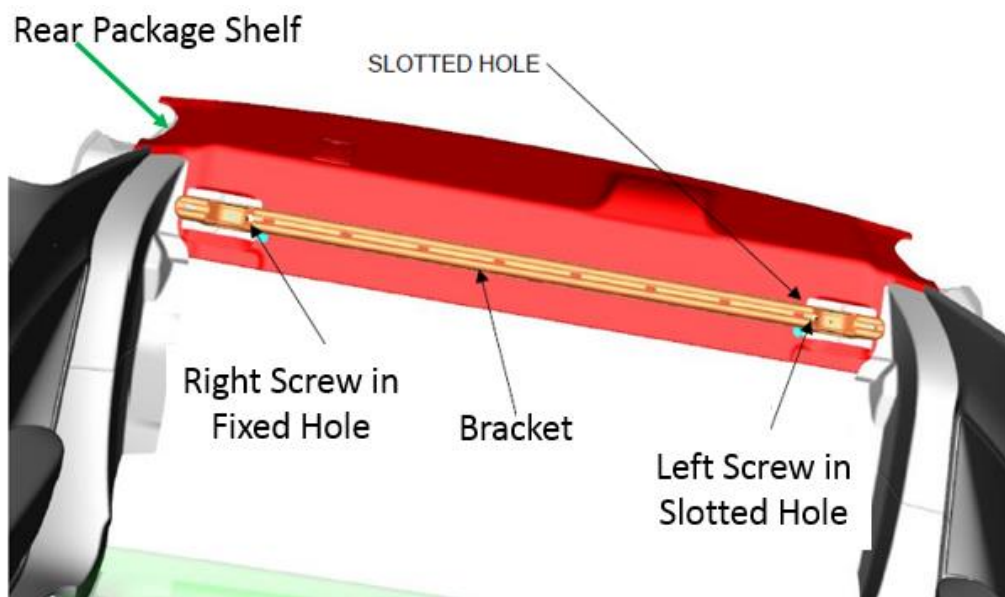

10. Secure the original Upper and Lower Quarter Trim Panels (left and right hand) using the push pin retained from Step #5. Reinstall the screw and SRS Label Caps from step #5 in the Upper Quarter Trim Panels (left and right hand). Reinstall the C-pillar Trim Panels from step #5 by first engaging the tether clips, then install panels to body.
11. Align the **new Back Panel** to vehicle by using the (4) slots on the bottom of the Back Panel and insert in the floor pan tether rings to align the part.

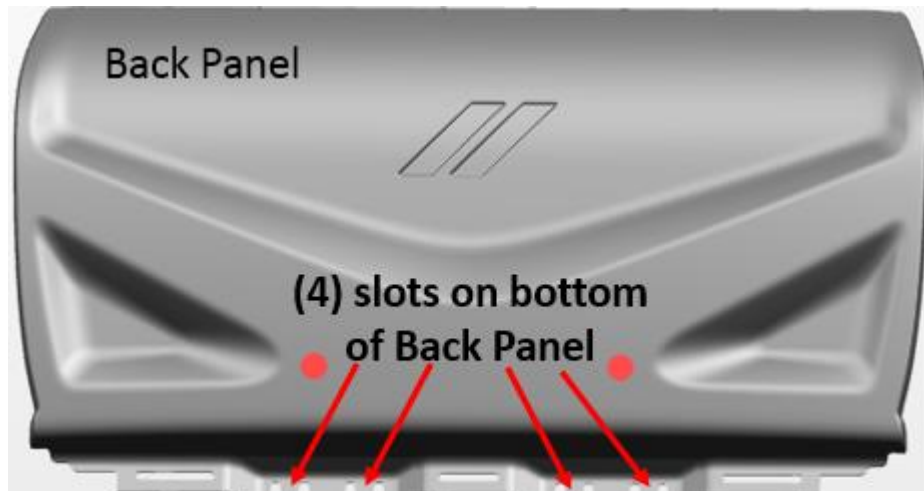

Step #11 continued:

Proceed to rotate the top of the Back Panel up towards the Shelf Panel and Clip into the previously installed new Bracket (Bracket installed in Step #9).

Line-up the pins located on the backside of the Back Panel to the holes in the slotted holes in the Bracket. Install the pins to the slotted holes using hand pressure.

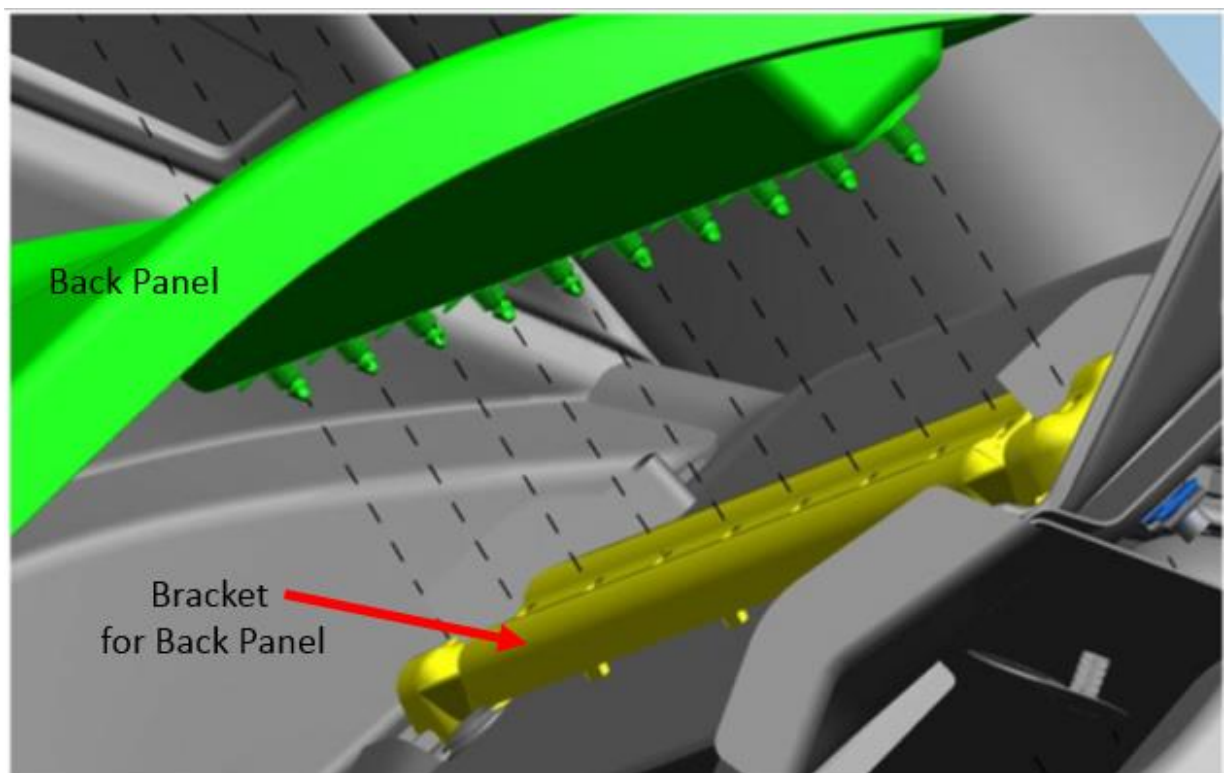

Align pins of Back Panel to slots in Bracket. Apply hand pressure to secure.

12. Align the **new Lower Floor Panel** to the Back Panel. Install Floor Trim Panel. Make sure to first push the Lower Floor Panel rearward and wedge under the Back Panel. Proceed to secure the two outboard attachments on the forward edge of Lower Floor Panel into the floor pan slots using hand pressure.

Align Lower Panel and wedge under Back Panel

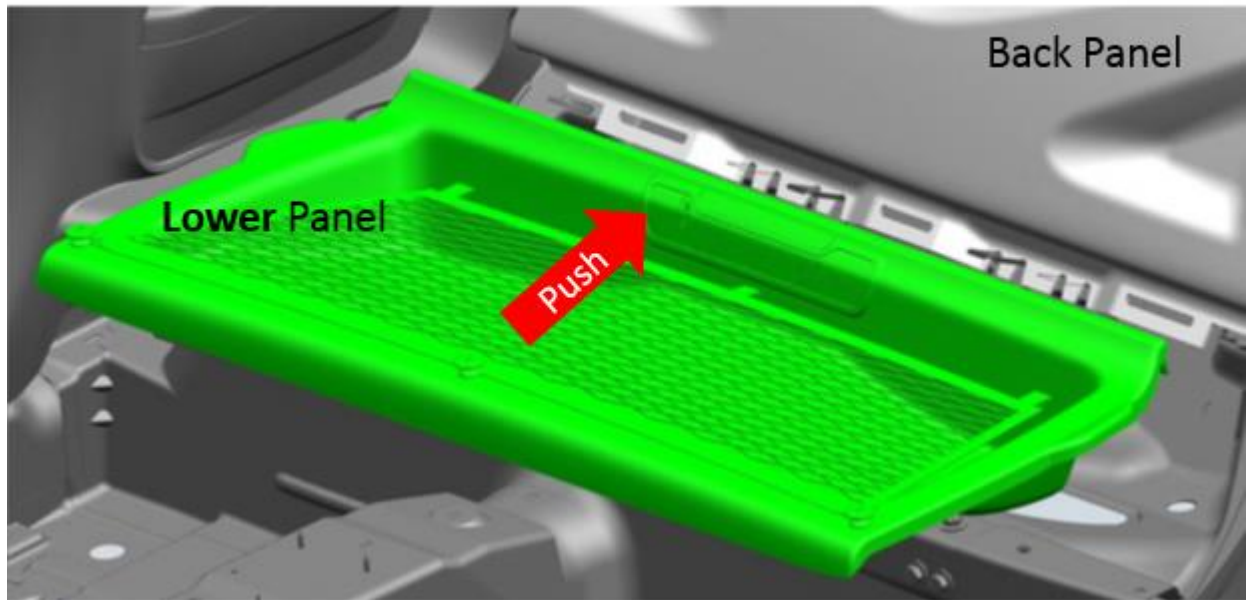

- Align (2) outboard attachments to the slots in floor pan and secure using hand pressure.

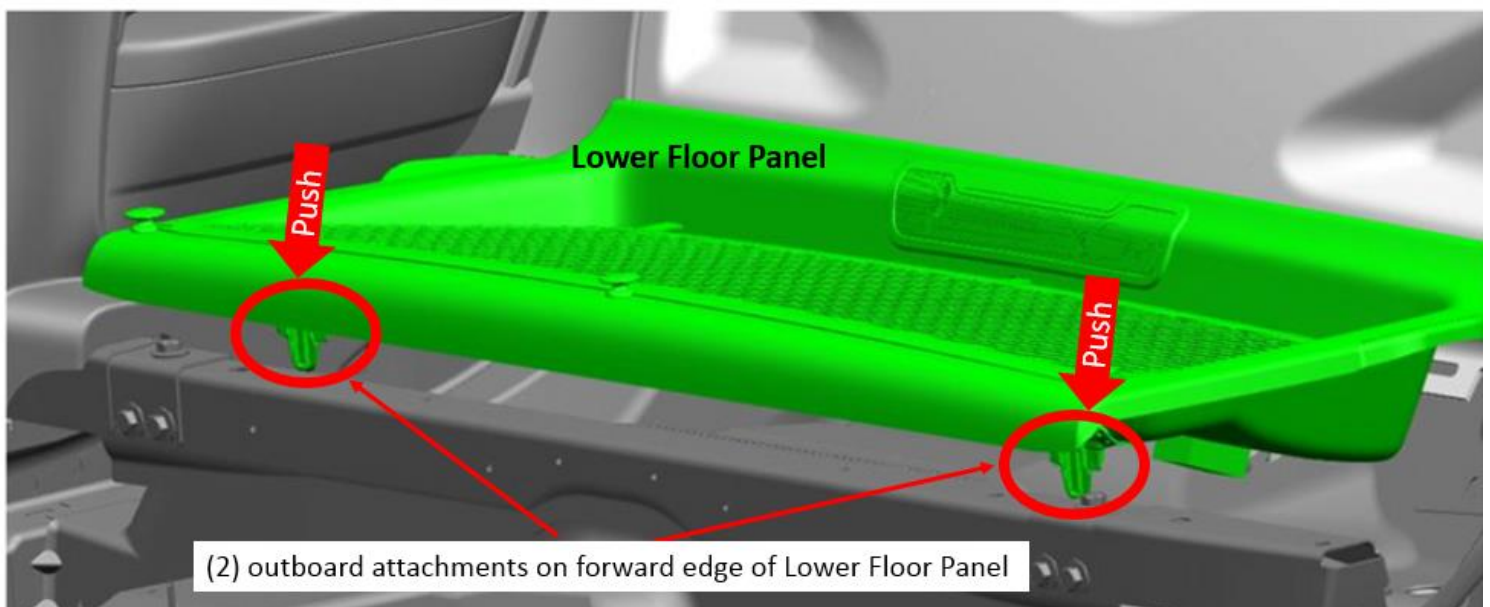

13. Install the **new Caps/Cover Trim** into the Upper Quarter Trim Panels (left and right hand) to close out the Seat Belt Webbing opening.

