

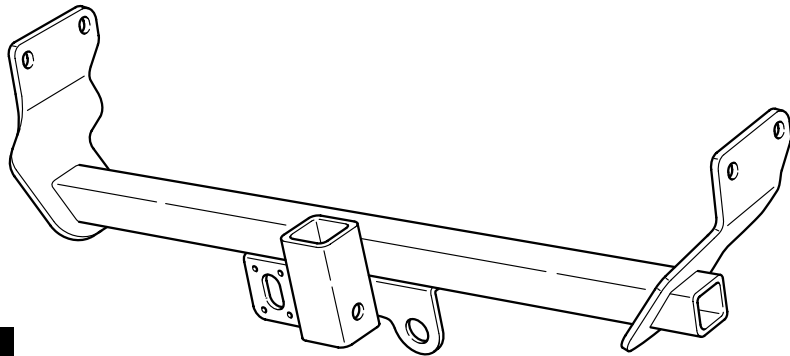

MOPAR®

# DODGE CALIBER

## Trailer Hitch



**A**

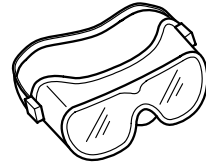

18mm

19mm

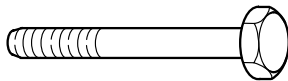
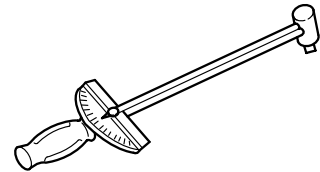
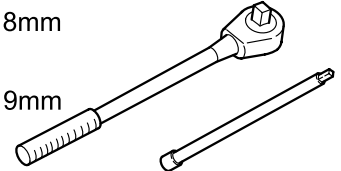

**B** 4x



**C** 4x



**D** 4x

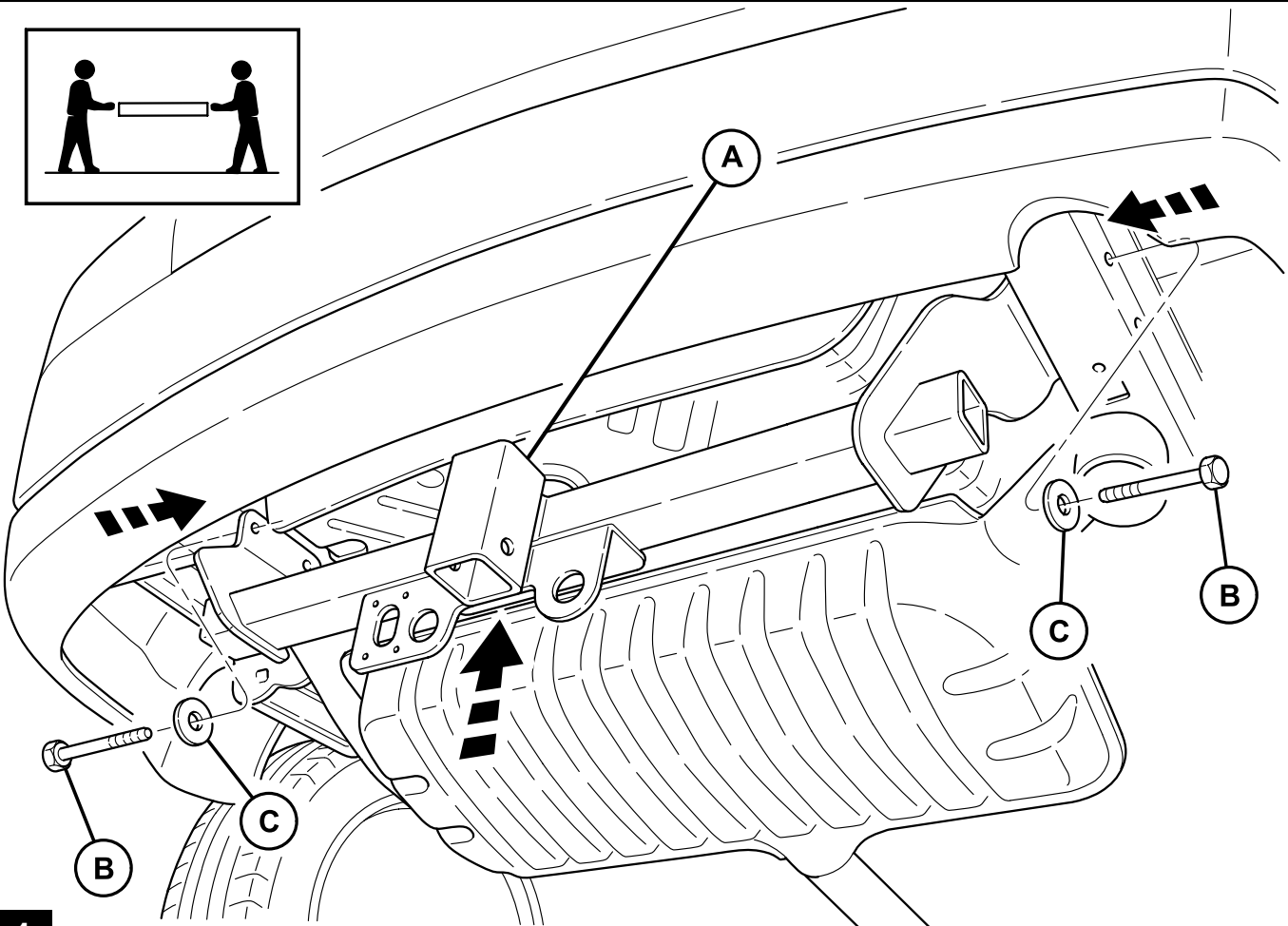
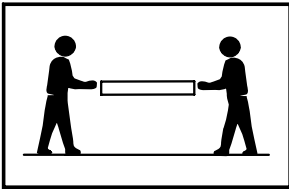

**1**

