

A



x10

C



x6

34201631

D

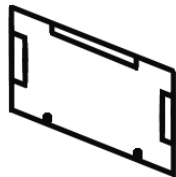

B



x2

E



5.5 mm



7 mm



10 mm

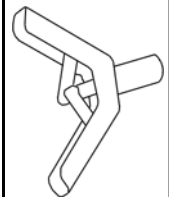
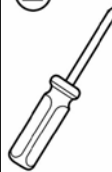
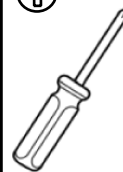

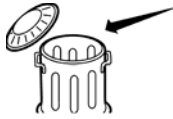
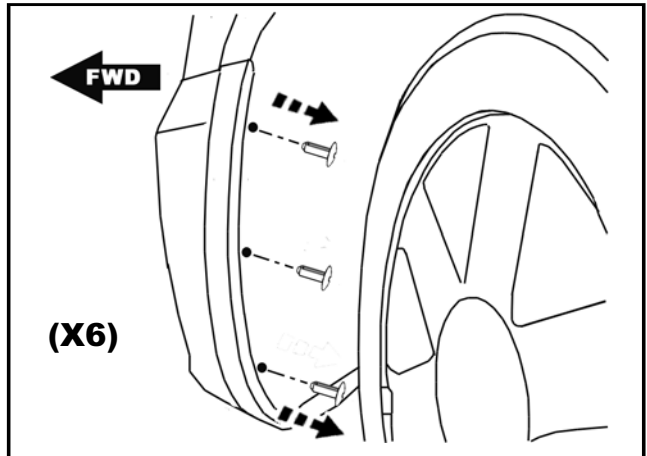
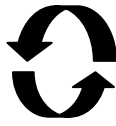
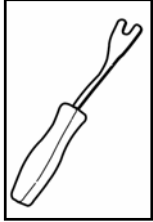

1

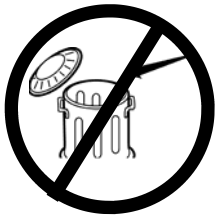
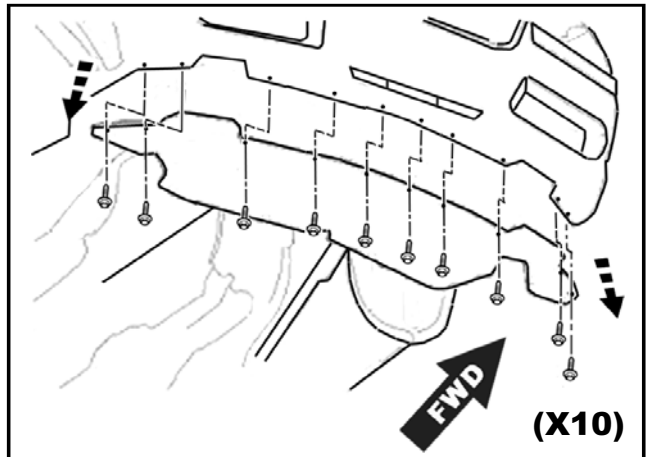
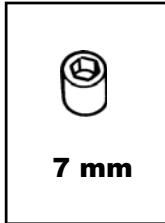
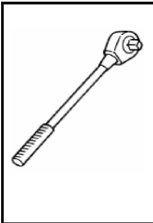

2

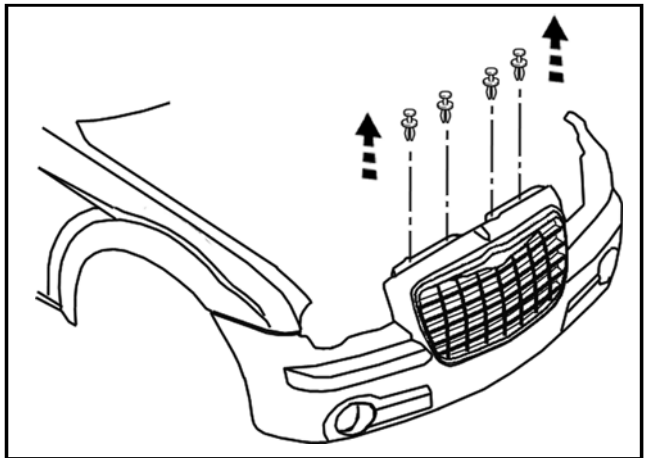
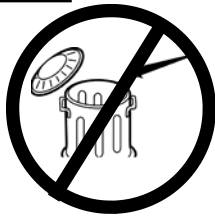
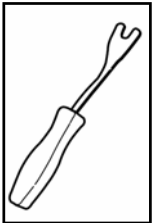

3

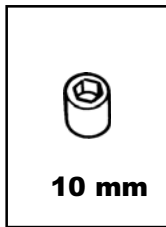
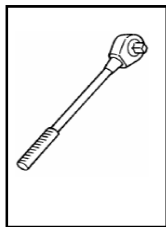

10 mm

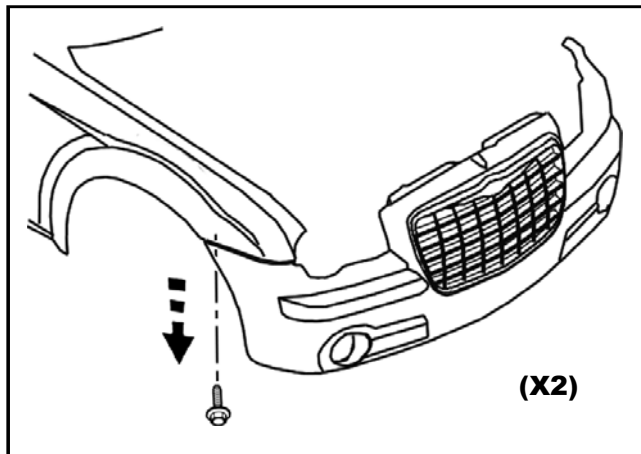
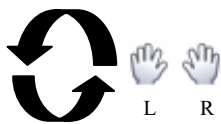

(X2)



4

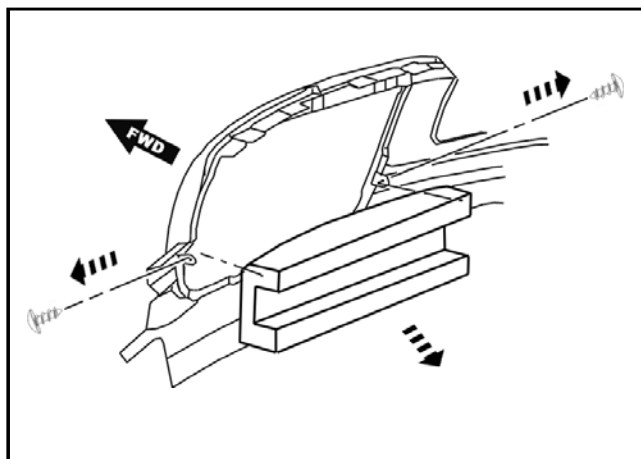
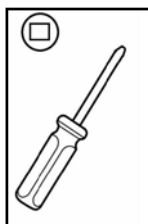

5

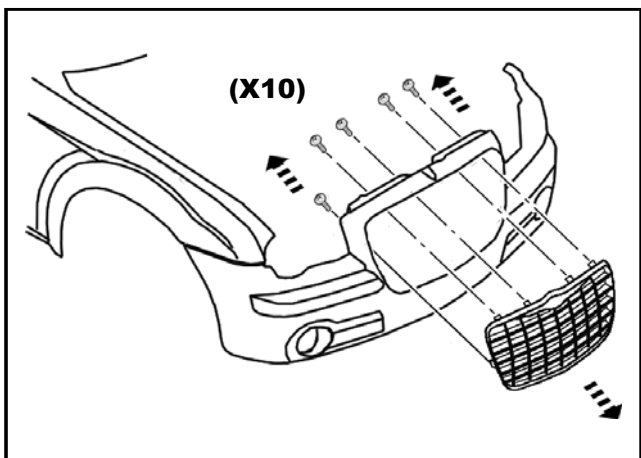
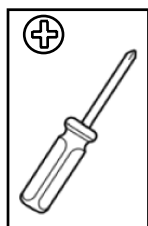

(X10)

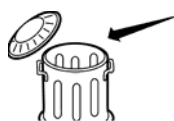

6

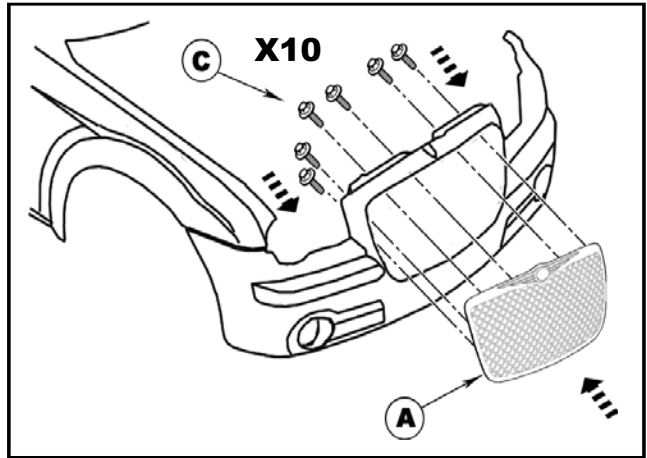
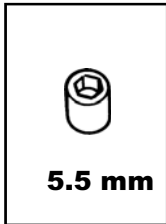
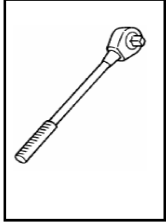

7

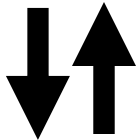

5

—

1

8

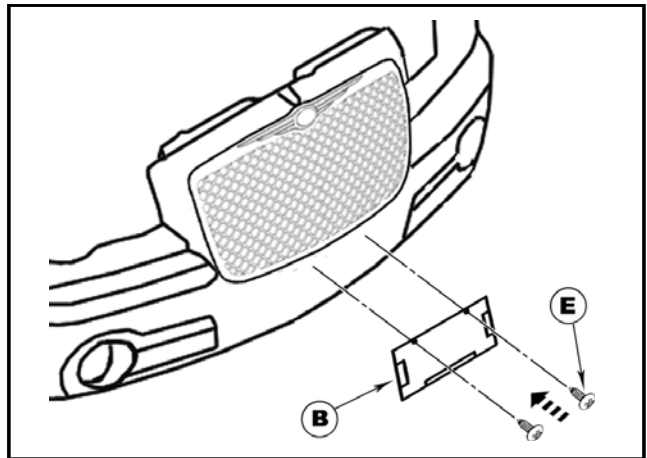
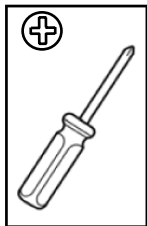

9