

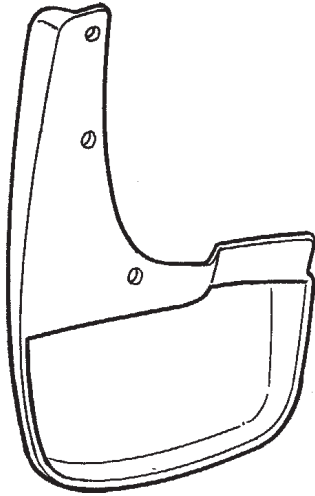

# DURANGO/ASPEN

## Rear Splashguard

Rear Left



**A**

Rear Right

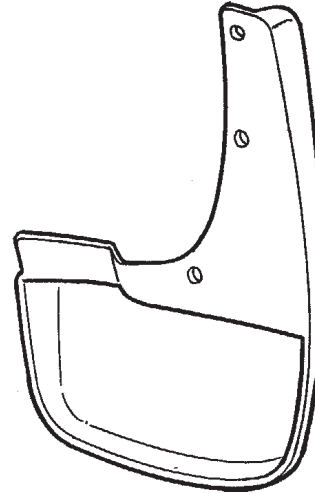

**B**

**C** 4X

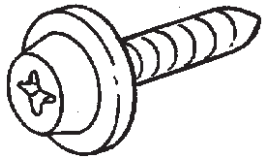

**D** 2X

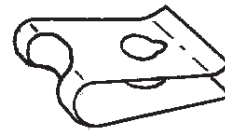

3/32" (2.5mm)  
1/4" (6.3 mm)

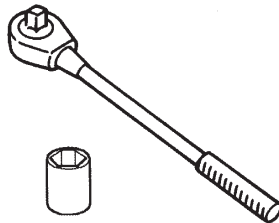

10mm  
Socket/Driver



#2

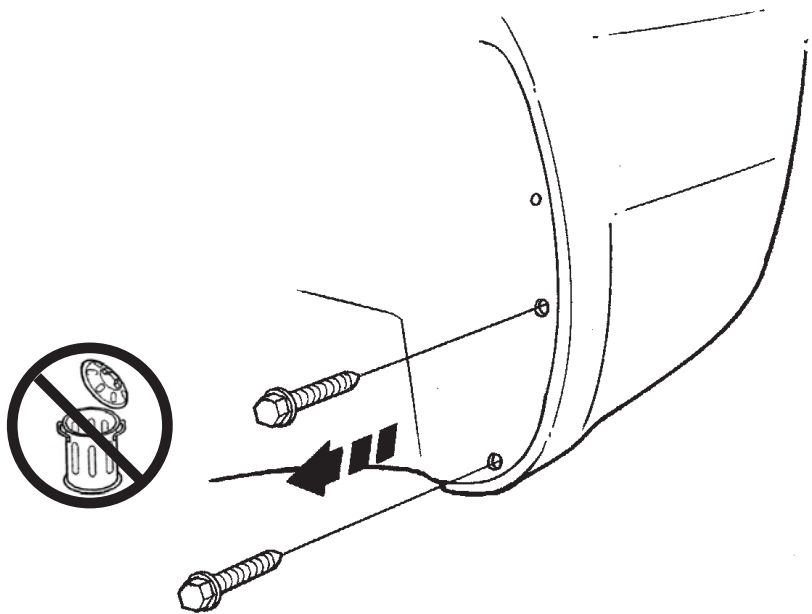

1

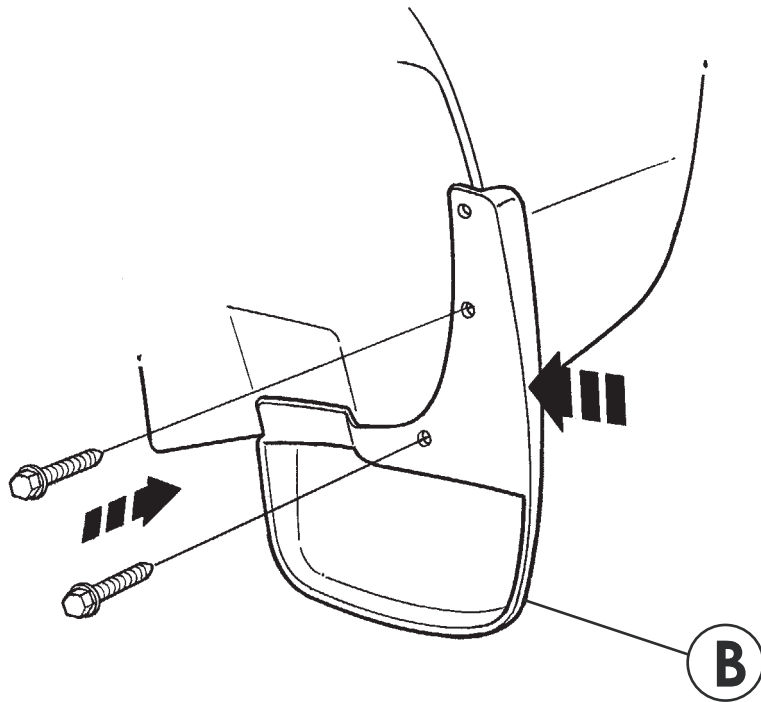

2

